

Technical Report

TR-10-14

Design, production and initial state of the canister

Svensk Kärnbränslehantering AB

December 2010

Svensk Kärnbränslehantering AB

Swedish Nuclear Fuel
and Waste Management Co

Box 250, SE-101 24 Stockholm
Phone +46 8 459 84 00



ISSN 1404-0344

SKB TR-10-14

ID 1198199

Updated 2013-10

Design, production and initial state of the canister

Svensk Kärnbränslehantering AB

December 2010

Keywords: Canister, Safety report, Design premise, Verification, Verifying analysis, Reference design, Production, Manufacturing, Inspection, Initial state.

A pdf version of this document can be downloaded from www.skb.se.

Update notice

The original report, dated December 2010, was found to contain both factual and editorial errors which have been corrected in this updated version. The corrected factual errors are presented below.

Updated 2011-12

Location	Original text	Corrected text
Page 29, section 3.1.1, paragraph 2	- iron content in nodular cast iron shall be > 90% - carbon content in nodular cast iron shall be < 4.5% - silicon content in nodular cast iron shall be < 6%	- iron content in nodular cast iron shall be > 90% - carbon content in nodular cast iron shall be < 6% - silicon content in nodular cast iron shall be < 4%
Page 50, section 4.7, paragraph 2	The content of these elements shall therefore be kept below 6% (Si) and 4.5% (C).	The content of these elements shall therefore be kept below 6% (C) and 4% (Si).
Page 55, section 4.11.5, paragraph 1, last line	The content of these elements shall therefore be kept below 6% (Si) and 4.5% (C).	The content of these elements shall therefore be kept below 6% (C) and 4% (Si).
Page 102, Table 7-1, first line	Carbon content (%); <4.5%; <4.5% Silicon content (%); <6%; <6%	Carbon content (%); <6%; <6% Silicon content (%); <4%; <4%
Page 108, section 7.1.6, paragraph 3	The carbon content is below 4.5% and the silicon content is below 6% in all manufactured inserts.	The carbon content is below 6% and the silicon content is below 4% in all manufactured inserts.
Page 110, section 7.2.5, paragraph 2	The iron (> 90%), silicon (< 6%) and carbon (< 4.5%) content in the insert is verified by conventional material analyses during production.	The iron (> 90%), silicon (< 4%) and carbon (< 6%) content in the insert is verified by conventional material analyses during production.

Updated 2013-01

Location	Original text	Corrected text
Page 24, Table 2-2, third column, second line	Fe > 90%, C < 4.5% and Si < 6%	Fe > 90%, C < 6% and Si < 4%
Page 90, Table 5-12, line S, column Specification	< 2	< 12

Updated 2013-10

Location	Original text	Corrected text
Table 5-1, row 10 (157), column 2 (Cu)	0.037	0.031
Table 5-1, row 10 (157), column 3 (C)	3.62	3.66
Table 5-1, row 10 (157), column 4 (Si)	2.30	2.34
Table 5-1, row 10 (157), column 5 (Mn)	0.16	0.18
Table 5-1, row 10 (157), column 6 (P)	0.025	0.023
Table 5-1, row 10 (157), column 7 (S)	0.006	0.007
Table 5-1, row 10 (157), column 8 (Ni)	0.40	0.38
Table 5-1, row 10 (157), column 9 (Mg)	0.045	0.044
Table 5-1, row 11 (Mean value), column 2 (Cu)	0.040	0.039
Table 5-1, row 11 (Mean value), column 3 (C)	3.61	3.62
Table 5-1, row 11 (Mean value), column 5 (Mn)	0.15	0.16
Table 5-1, row 11 (Mean value), column 7 (S)	0.006	0.007
Table 5-1, row 12 (Standard deviation), column 2 (Cu)	0.005	0.007
Table 5-1, row 12 (Standard deviation), column 4 (Si)	0.02	0.03
Table 5-1, row 12 (Standard deviation), column 5 (Mn)	0.01	0.02
Table 5-1, row 12 (Standard deviation), column 8 (Ni)	0.005	0.007

Preface

An important part of SKB's licence application for the construction, possession and operation of the KBS-3 repository is the safety report. The safety report addresses both safety during operation of the KBS-3 repository facility (**SR-Operation**), and the long-term safety of the KBS-3 repository (**SR-Site**).

For the construction of the KBS-3 repository SKB has defined a set of production lines:

- the spent nuclear fuel,
- the canister,
- the buffer,
- the backfill,
- the closure,
- the underground openings.

These production lines are reported in separate *Production reports*, and in addition there is a *Repository production report* presenting the common basis for the reports.

This set of reports addresses design premises, reference design, conformity of the reference design to design premises, production and the initial state, i.e. the results of the production. Thus the reports provide input to **SR-Site** concerning the characteristics of the as built KBS-3 repository and to **SR-Operation** concerning the handling of the engineered barriers and construction of underground openings.

The preparation of the set of reports has been lead and coordinated by Lena Morén with support from Roland Johansson, Karin Pers and Marie Wiborgh.

This report has been authored by Lars Cederqvist, Magnus Johansson, Nina Leskinen and Ulf Ronneteg.

Summary

The report is included in a set of *Production reports*, presenting how the KBS-3 repository is designed, produced and inspected. The set of reports is included in the safety report for the KBS-3 repository and repository facility.

The report provides input on the *initial state* of the canisters to the assessment of the long-term safety, **SR-Site**. The initial state refers to the properties of the engineered barriers once they have been finally placed in the KBS-3 repository and will not be further handled within the repository facility. In addition, the report provides input to the operational safety report, **SR-Operation**, on how the canisters shall be handled and disposed.

The report presents the design premises and reference design of the canister and verifies the conformity of the reference design to the design premises. The production methods and the ability to produce canisters according to the reference design are described. Finally, the initial state of the canisters and their conformity to the reference design and design premises are presented.

Design premises for the canister

The design premises for the canister are based on regulations; the functions of the KBS-3 repository; the design basis cases from the assessment of the long-term safety; the design basis events from the assessment of the operational safety; technical feasibility and the planned production.

In the KBS-3 repository the canister shall contain the spent nuclear fuel and prevent the release of radioactive substances into the surroundings. The canister shall also shield radiation and prevent criticality. Main properties of the canister of importance for its barrier functions are the copper shell thickness and its creep ductility, and the strength and pressure bearing capacity of the canister insert. Design premises for the loads and conditions the canister shall be designed to withstand in the KBS-3 repository are provided from the assessment of the long-term safety. The design premises of most importance for the design of the canister are that the corrosion barrier, i.e. the copper shell, shall be made of highly pure copper with a thickness of 5 cm and that the canister shall withstand an isostatic pressure of 45 MPa and an arbitrary shearing of 5 cm.

The canister shall also be designed to prevent the release of radioactive substances during transportations and in the KBS-3 repository facility during operation. It shall also conform to design premises related to technical feasibility and production. With respect to technical feasibility the canister imposes design premises for the buffer, and with respect to transports and operation of the facilities the canister imposes design premises for the loads and conditions it may be exposed to in order to be fit for deposition.

The reference design of the canister and its conformity to the design premises

The copper shell, i.e. tube, lid and base, are made of highly pure copper. The copper components are welded together by friction stir welding (FSW). To facilitate handling of the canister, the copper lid is provided with a flange to allow handling equipment to grip the canister. The insert is manufactured of nodular cast iron with steel channel tubes in which the fuel assemblies are to be positioned. The reference canister design comprises two different inserts, one for 12 BWR fuel assemblies and one for 4 PWR fuel assemblies.

With respect to corrosion the design premises stipulates a certain copper quality and thickness and thus the analysis of the conformity of the reference design to the design premises is straight forward for the copper shell as a corrosion barrier. The verifications of the mechanical integrity of the canister under loading conditions are made by modelling and various calculations. The material model for the copper shell is based on data from manufactured components and is a combined elastoplastic and creep model. The analyses show that the copper shell remains intact under the mechanical loads given by the design premises as long as the insert remains intact. A damage tolerance analysis gives the defect sizes in the insert that can be accepted in the manufacturing and that shall be possible to identify in inspections with non destructive testing.

Further, analysis of the propensity for criticality of the encapsulated spent fuel assemblies shows that the reference canister prevents criticality. It is also verified that the reference canister shields the radiation from the encapsulated spent fuel to acceptable levels.

The production of the canister

The production system for the manufacturing of canisters comprises a network of suppliers who manufacture the canister components and a canister factory run by SKB where the final machining and inspections and the assembly of the canisters is carried out. The canister is sealed in the encapsulation plant.

The reference method to manufacture the insert is casting of nodular cast iron. The reference methods to manufacture the copper shell are casting of copper ingot, extrusion of copper tube, forging of copper lid and base and welding by means of friction stir welding.

The canister components and welds are inspected to ensure the conformity to the specifications for the reference design. This is done in accordance to established standards and also on the basis of procedures developed by SKB. The inspections comprise of non-destructive testing (NDT), destructive testing, material analysis and dimension inspections.

The production of the canister comprise the main parts manufacturing of inserts, manufacturing of copper tubes, manufacturing of copper lids and copper bases, and welding of copper bases. Each part is divided into several stages. Production-inspection schemes presenting the processes performed to alter and/or inspect the canister design parameters in each stage are included in the report. The report also briefly describes the assembly of the canister, the encapsulation, transportation, handling, and deposition of the canisters.

Experiences and results from performed trial manufacturing show that inserts for BWR fuel assemblies, copper components and welds can be produced within the acceptable variations specified for the reference design. This includes geometrical variations, variations in material properties and acceptable defects. The manufacturing process for the PWR insert is not developed to the same level as for the BWR inserts.

The initial state of the canister

The initial state of the canister is defined as the state when the canister is finally deposited in the repository. The presented initial state is based on the current experiences and results from the trial manufacturing of canister components and completed welds. The initial state values are for many of the design parameters equal to the reference design, e.g. material composition, material properties and dimensions. The reason is that the reference design is based on the specifications that the suppliers follow during test manufacturing and the material properties specified for the reference design is based on available data from test samples and manufacturing.

The manufactured thicknesses of the copper shell may locally be reduced due to the occurrence of internal defects and surface damages occurring during handling, transportation or deposition. The only type of defect that has been detected in the welds at normal operation is joint line hooking, reducing the thickness locally with few millimetres. Based on the fact that the possible manufacturing defects in the rest of the copper shell mainly propagate perpendicular to the corrosion barrier and on the experience from inspections of the canister components, the welds are considered to be the potentially thinnest part of the copper shell.

Sammanfattning

Rapporten ingår i en grupp av *Produktionsrapporter* som redovisar hur KBS-3-förvaret är utformat, producerat och kontrollerat. Gruppen av rapporter ingår i säkerhetsredovisningen för KBS-3-förvaret och försvarsanläggningen.

Rapporten redovisar indata om kapslarnas *initialtillstånd* till analysen av långsiktig säkerhet, **SR-Site**. Initialtillståndet avser egenskaperna hos de tekniska barriärerna då de slutligt satts på plats i slutförvaret och inte hanteras ytterligare inom slutförvarsanläggningen. Dessutom ger rapporten information till driftsäkerhetsredovisningen, **SR-Drift**, om hur kapslarna ska hanteras och deponeras.

Rapporten redovisar kapselns konstruktionsförutsättningar och referensutformning, och verifierar referensutformningens överensstämmelse med konstruktionsförutsättningarna. Rapporten beskriver också tillverkningsmetoderna och förmågan att tillverka och deponera kapslar som överensstämmer med referensutformningen. Slutligen redovisas kapslarnas initialtillstånd och deras överensstämmelse med referensutformningen och konstruktionsförutsättningarna.

Konstruktionsförutsättningar för kapseln

Konstruktionsförutsättningarna för kapseln är baserade på föreskrifter, KBS-3-förvarets funktioner, konstruktionsstyrande fall från analysen av långsiktig säkerhet, konstruktionsstyrande händelser från redovisningen av driftsäkerhet, teknisk genomförbarhet och den planerade tillverkningen.

I KBS-3-förvaret ska kapseln innesluta det använda kärnbränslet och förhindra spridning av radioaktiva ämnen till omgivningen. Kapseln ska också dämpa strålning och förhindra kriticitet. De egenskaper hos kapseln som har stor betydelse för dess barriärfunktioner är kopparhöljets tjocklek och kryptuktilitet samt insatsens tryck- och skjuvhållfasthet. Konstruktionsförutsättningarna avseende laster och förhållanden som kapsel ska utformas för att motstå i KBS-förvaret ges av analysen av den långsiktiga säkerheten. De konstruktionsförutsättningar som har störst betydelse för kapselns utformning är att korrosionsbarriären, det vill säga kopparhöljet, ska tillverkas av ren koppar och vara 5 cm tjockt samt att kapseln ska motstå ett isostatiskt tryck på 45 MPa och en godtycklig skjuvning på 5 cm.

Kapseln ska också utformas så att den förhindrar spridning av radioaktiva ämnen under transport och vid drift av försvarsanläggningen. Kapseln ska också överensstämma med konstruktionsförutsättningar från andra tekniska barriärer och från tillverkningen. Med hänsyn till teknisk genomförbarhet ger kapseln konstruktionsförutsättningar för bufferten och med avseende på transporter och drift av anläggningarna ger kapseln konstruktionsförutsättningar för belastningar och förhållanden som den kan utsättas för och ändå vara tillåten för deponering.

Kapselns referensutformning och dess överensstämmelse med konstruktionsförutsättningarna

Kopparhöljet, det vill säga rör, lock och botten, tillverkas av ren koppar. Kopparkomponenterna svetsas samman med friktionssvetsning (FSW). För att underlätta hanteringen av den förslutna kapseln har kopparlocket försetts med en fläns som hanteringsutrustning kan greppa i. Insatsen tillverkas av segjärn och har en stålkassett med kanaler där bränsleelementen placeras. Referenskapselns insats finns i två varianter, en som rymmer tolv bränsleelement från BWR-reaktorer och en som rymmer fyra bränsleelement från PWR-reaktorer.

Eftersom konstruktionsförutsättningarna för korrosionsbarriären är att kapselns hölje vara tillverkat av ren koppar och ha en viss tjocklek är analysen av att referensutformningen överensstämmer med konstruktionsförutsättningarna trivial. Verifikationen av kapselns mekaniska integritet vid belastningar omfattar modelleringar och beräkningar. Materialmodellen för kopparhöljet baseras på data från tillverkade komponenter och är en kombination av en elastoplastisk och en kryptmodell. Analyserna visar att kopparhöljet förblir intakt vid de laster som anges i konstruktionsförutsättningarna så länge insatsen är intakt. En skadetålighetsanalys anger storleken på de defekter i insatsen som kan accepteras vid tillverkningen och som måste vara möjliga att upptäcka med oförstörande provning.

Tillverkning, hantering och deponering av kapslar

Produktionssystemet för tillverkning av kapslar består av ett nätverk av leverantörer som tillverkar kapselkomponenter och en kapselabrik som drivs av SKB där slutlig bearbetning och kontroll samt montering av komponenterna till kapslarna genomförs. Kapslarna försluts i inkapslingsanläggningen.

Referensmetoden för tillverkning av insatser är gjutning i segjärn. Referensmetoderna för tillverkning av kopparhöljet är gjutning av koppargöt, extrusion av kopparrör, smide av kopparlock och botten samt friktionssvetsning.

Kapselkomponenterna och svetsarna kontrolleras för att säkerställa att de överensstämmer med referensutformningen. Detta görs i enlighet med etablerade standarder eller enligt de förfaranden som SKB utarbetar. Kontrollerna omfattar oförstörande provning (OFP), förstörande provning, materialanalyser och dimensionskontroller.

Produktionen av kapseln omfattar huvuddelarna tillverkning av insatser, tillverkning av kopparrör, tillverkning av kopparlock och botten samt svetsning av kopparbotten och lock. Varje huvuddel är indelad i flera produktionssteg. Produktion-kontrollschema som beskriver processerna som genomförs för att förändra och/eller kontrollera kapselns utformningsparametrar i varje steg finns i rapporten. Rapporten beskriver dessutom montering, inkapsling, transporter, hantering och deponering av kapslar översiktligt.

Erfarenheter och resultat från genomförd provtillverkning visar att BWR-insatser, kopparkomponenter och svetsar kan tillverkas i överensstämmelse med de acceptabla variationer som angivits för referensutformningen. Detta gäller variationer i geometri, materialegenskaper och materialsammansättning samt acceptabla defekter. Tillverkningsprocessen för insatser för bränsleelement från PWR-reaktorer är ännu inte utvecklad till samma nivå som för BWR-insatser.

Kapseln initialtillstånd

Kapselns initialtillstånd är tillståndet när den slutligen har deponerats i slutförvaret. Det redovisade initialtillståndet baseras på erfarenheter och resultat från genomförd provtillverkning av kapselkomponenter och utförda svetsar. Det redovisade initialtillståndet sammanfaller för flertalet av utformningsparametrarna med de värden som specificerar kapselns referensutformning, till exempel materialsammansättning, materialegenskaper och dimensioner. Anledningen är att referensutformningen baseras på de tillverknings-specifikationer som leverantörerna följer vid provtillverkningen. De materialegenskaper som anges i referensutformningen baseras på data från materialprover och tillverkade komponenter.

Tjockleken på det tillverkade kopparhöljet kan lokalt reduceras på grund av inre defekter i höljet och ytskador som kan tillkomma under hantering, transport och deponering. Den enda typ av defekt som har hittats i svetsar producerade vid normal drift är så kallad foglinjeböjning, som lokalt kan reducera koppardtjockleken med några få millimeter. Baserat på erfarenheter från tillverkningen förväntas utbredningen av eventuella defekter i resten av kopparhöljet vara vinkelrät mot korrosionsbarriären, och baserat på resultat från genomförda kontroller av kopparkomponenterna anses för närvarande svetsarna vara den del av kopparhöljet som är tunnast.

Contents

1	Introduction	13
1.1	General basis	13
1.1.1	This report	13
1.1.2	The design of the canister	13
1.1.3	The production of the canister	14
1.2	Purpose, objectives and limitations	14
1.2.1	Purpose	14
1.2.2	Objectives	14
1.2.3	Limitations	14
1.3	Interfaces to other reports included in the safety report	15
1.3.1	The safety report for the long-term safety	15
1.3.2	The safety report for the operational safety	15
1.3.3	The other production reports	15
1.4	Structure and content	16
1.4.1	Overview	16
1.4.2	Design premises	16
1.4.3	Reference design	16
1.4.4	Conformity of the reference design to the design premises	16
1.4.5	Manufacturing of the canister	16
1.4.6	Encapsulation, transportation, handling and deposition	17
1.4.7	Initial state of the canister	17
2	Design premises for the canister	19
2.1	General basis	19
2.1.1	Identification and documentation of design premises	19
2.1.2	Definition, purpose and basic design	19
2.2	Barrier functions and design considerations	20
2.2.1	Barrier functions in the KBS-3 repository and functions in the facilities	20
2.2.2	Design considerations	21
2.3	Design premises	21
2.3.1	Design premises related to the barrier functions in the KBS-3 repository	22
2.3.2	Design premises from the spent fuel	22
2.3.3	Design premises from the other engineered barriers and underground openings	22
2.3.4	Design premises related to the production and operation	22
2.4	Design premises imposed by the canister	22
2.4.1	Requirements on the handling of the spent nuclear fuel	22
2.4.2	Design premises for the other barriers	25
2.4.3	Design premises for the facilities and the transportation system of the KBS-3 system	25
3	Canister reference design	27
3.1	Insert	28
3.1.1	Material composition	29
3.1.2	Material properties	29
3.1.3	Dimensions	29
3.2	Copper components and weld	32
3.2.1	Material composition	32
3.2.2	Material properties	32
3.2.3	Dimensions	32
4	Conformity of the reference design to the design premises	35
4.1	Structure of the analyses	35
4.2	Conditions for the analyses of mechanical loads	36

4.2.1	Insert	36
4.2.2	Copper	37
4.3	Isostatic load in the repository	37
4.3.1	Analyses of the insert	38
4.3.2	Analysis of the copper shell	41
4.4	Shear load in the repository	45
4.4.1	Analyses of the insert	45
4.4.2	Analysis of the copper shell	48
4.5	Uneven swelling pressure from bentonite buffer	48
4.5.1	Analyses of uneven swelling pressure	48
4.6	Corrosion load	50
4.7	Prevention of criticality	50
4.8	Additional design premises derived from the safety assessment	50
4.9	Design premises from the spent nuclear fuel	51
4.10	Design premises related to production and operation	51
4.10.1	Mechanical loads during handling in the facilities	51
4.10.2	Average grain size of the copper	52
4.11	Summary of results and conclusions	53
4.11.1	Isostatic load in the repository	53
4.11.2	Shear load in the repository	54
4.11.3	Uneven pressure from bentonite buffer	54
4.11.4	Corrosion load	55
4.11.5	Prevention of criticality	55
4.11.6	Additional design premises derived from the safety assessment	55
5	Manufacturing of canisters	57
5.1	Overview	57
5.1.1	Reference methods for manufacturing of canisters	58
5.1.2	Strategy for inspections	58
5.1.3	Requirements for the manufacturing of canisters	58
5.1.4	Design parameters and production-inspection schemes	58
5.2	Manufacturing of insert	59
5.2.1	Production inspection scheme for the manufacturing of the insert	59
5.2.2	Manufacturing of steel lid	60
5.2.3	Manufacturing of steel tube cassette	60
5.2.4	Casting	61
5.2.5	Machining	62
5.2.6	Inspection of the material composition	62
5.2.7	Inspection of the material properties by means of destructive testing	62
5.2.8	Inspection of defects by non-destructive testing	62
5.2.9	Dimension inspection	63
5.2.10	Results of test manufacturing	63
5.3	Manufacturing of copper tubes	68
5.3.1	Production inspection scheme for the manufacturing of the copper tube	68
5.3.2	Casting of copper ingots for tubes	69
5.3.3	Extrusion	70
5.3.4	Machining	72
5.3.5	Inspection of the material composition	72
5.3.6	Inspection of the material properties	72
5.3.7	Inspection of defects by non-destructive testing	72
5.3.8	Dimension inspection	73
5.3.9	Results of test manufacturing	73
5.4	Manufacturing of copper lids and copper bases	77
5.4.1	Production inspection scheme for the manufacturing of the copper lids and bases	77
5.4.2	Casting of copper ingots for lids and bases	78
5.4.3	Forging	78
5.4.4	Machining	79

5.4.5	Inspection of the material composition	80
5.4.6	Inspection of the material properties	80
5.4.7	Inspection of defects by non-destructive testing	80
5.4.8	Dimension inspection	81
5.4.9	Results of test manufacturing	81
5.5	Welding of bases	84
5.5.1	Production inspection scheme for the welding of the copper base	84
5.5.2	Friction stir welding	85
5.5.3	Machining	87
5.5.4	Welding process control	87
5.5.5	Inspection of defects by non-destructive testing	87
5.5.6	Dimension inspection	88
5.5.7	Results of welding tests	88
5.6	Assembly of canister	92
5.7	Transport of the assembled canister to the encapsulation plant	92
6	Encapsulation, transportation, handling and deposition	95
6.1	Overview	95
6.1.1	Encapsulation	96
6.1.2	Transportation	96
6.1.3	Handling and deposition	96
6.2	Canister to encapsulation plant	96
6.2.1	Delivery and placement in position for placing the fuel	96
6.2.2	Mounting of the copper lid	97
6.2.3	Inspection	97
6.3	Copper lid welded to canister by friction stir welding	97
6.3.1	Friction stir welding	97
6.3.2	Machining	97
6.3.3	Welding process control	97
6.3.4	Inspections	97
6.4	Placement of canister in a transport cask	98
6.4.1	Insertion	98
6.4.2	Inspection	99
6.5	Transportation of KTB with canister from the encapsulation plant to final repository facility	99
6.5.1	Road transport to the harbour	99
6.5.2	Sea transport	99
6.5.3	Road transport from receiving port harbour to final repository facility	99
6.5.4	Inspection	99
6.6	Transportation of KTB down to reloading station at repository depth	99
6.6.1	Reloading in terminal building	99
6.6.2	Transportation to repository depth	99
6.6.3	Inspection	99
6.7	Reloading of the canister from the KTB to the deposition machine	100
6.7.1	Reloading	100
6.7.2	Inspections	100
6.8	Deposition	100
6.8.1	Inspection	100
7	Initial state of the canister	101
7.1	Initial state and conformity to the reference design	101
7.1.1	Initial state	101
7.1.2	Isostatic load in the repository	102
7.1.3	Shear load in the repository	104
7.1.4	Uneven pressure from bentonite buffer	105
7.1.5	Corrosion load	105
7.1.6	Prevention of criticality	108
7.2	Conformity to design premises long-term safety at the initial state	108
7.2.1	Isostatic load in the repository	109

7.2.2	Shear load in the repository	109
7.2.3	Uneven pressure from bentonite buffer	110
7.2.4	Corrosion load	110
7.2.5	Prevention of criticality	110
7.2.6	Additional design premises	110
8	References	111
Appendix A	Initial state of the variables used for the long term evolution of the canister cast iron insert and copper shell	113
Appendix B	Glossary of abbreviations and specialised terms used in Canister production report	115

1 Introduction

1.1 General basis

1.1.1 This report

This report presents the reference design, production and initial state of the canister in the KBS-3 repository for spent nuclear fuel. It is included in a set of reports presenting how the KBS-3 repository is designed, produced and inspected. The set of reports is denominated *Production reports*. The Production reports and their short names used as references within the set are illustrated in Figure 1-1. The reports within the set referred to in this report and their full names are presented in Table 1-1

This report is part of the safety report for the KBS-3 repository and repository facility, see **Repository production report**, Section 1.2. It is based on the results and review of the most recent long-term safety assessment, the current knowledge, technology and results from research and development.

1.1.2 The design of the canister

The presented design of the canister presumes a repository based on the KBS-3 method with vertical deposition of canisters in individual deposition holes as further described in Chapter 3 in the **Repository production report**.

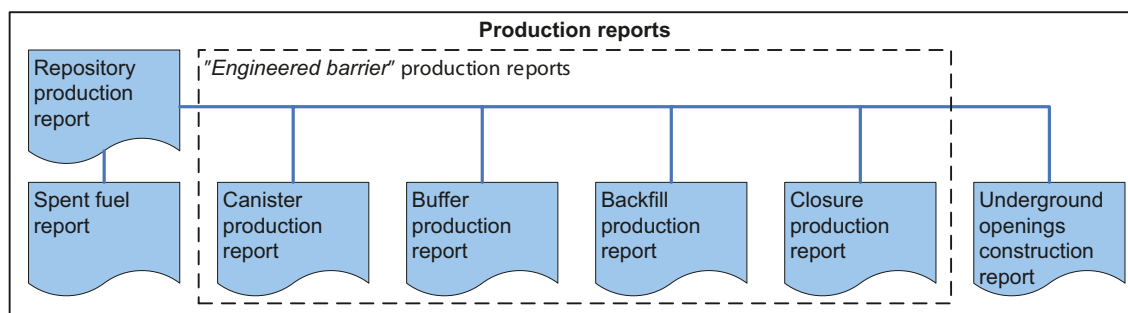

Figure 1-1. The reports included in the set of reports presenting how the KBS-3 repository is designed, produced and inspected.

Table 1-1. The reports within the set of Production reports referred to in this report.

Full title	Short name used within the Production line reports	Text in reference lists
Design and production of the KBS-3 repository	Repository production report	Repository production report, 2010. Design and production of the KBS-3 repository. SKB TR-10-12, Svensk Kärnbränslehantering AB.
Spent nuclear fuel for disposal in the KBS-3 repository	Spent fuel report	Spent fuel report, 2010. Spent nuclear fuel for disposal in the KBS-3 repository. SKB TR-10-13, Svensk Kärnbränslehantering AB.
Design, production and initial state of the buffer	Buffer production report	Buffer production report, 2010. Design, production and initial state of the buffer. SKB TR-10-15, Svensk Kärnbränslehantering AB.
Design, construction and initial state of the underground openings	Underground openings construction report	Underground openings construction report, 2010. Design, construction and initial state of the underground openings. SKB TR-10-18, Svensk Kärnbränslehantering AB.

The reference design of the canister and the reference methods to produce the canister presented in this report constitutes a solution that is technically feasible. It is, however, foreseen that the design premises, the design as well as the presented methods for production, test and inspection will be further developed and optimised before the actual construction of the KBS-3 repository facility commences. In this context, it should be mentioned that there are alternative designs that conform to the design premises as well as alternative ways to produce the reference design. In addition, the safety assessment SR-Site, as well as future safety assessments, may result in up-dated design premises. SKB's objective is to continuously develop and improve both the design and production.

1.1.3 The production of the canister

The presented production of the canister is based on that there is a system, the KBS-3 system comprising the facilities required to manage the spent nuclear fuel and finally deposit it in a KBS-3 repository. The KBS-3 system and its facilities etc are presented in Chapter 4 in the **Repository production report**.

The presented handling and deposition of the canister is a key activity in the facilities and transport system of the KBS-3 system. An overview of the handling of the canister within the KBS-3 system is given in Section 4.1 in the **Repository production report**.

1.2 Purpose, objectives and limitations

1.2.1 Purpose

The purpose of this report is to describe how the canister is designed, produced and inspected in a manner related to its importance for the safety of the KBS-3 repository. The report shall provide the information on the design, production and initial state of the canister required for the long-term safety report, **SR-Site**, as well as the information on how to seal, handle and inspect it required for the operational safety reports of the nuclear facilities and transport system of the KBS-3 system.

With this report SKB intends to present the design premises for the canister and demonstrate how it can be designed and produced to conform to the stated design premises. The report shall present the reference design, production and inspection methods and summarise the research and development efforts that supports that the canister can be produced in conformity to the design premises.

1.2.2 Objectives

Based on the above purpose, the objectives of this report are to present:

- the design premises for the canister,
- the reference design of the canister,
- the conformity of the reference design to the design premises,
- the planned production,
- the initial state of the canister, i.e. the expected result of the production comprising as built data on the properties taken credit for as contributing to, or affecting, the barrier functions and safety.

1.2.3 Limitations

The **Canister production report** primarily includes design premises related to the long-term safety of the KBS-3 repository. It also includes design premises related to the safe operation of the facilities etc included in the KBS-3 system. The presented reference design must conform to these design premises and consequently they have, in most cases, determined the design. Design premises related to aspects other than safety and radiation protection are only included if they have determined the design of the canister or the production methods.

The **Canister production report** also includes the design considerations taken with respect to the application of best available techniques with regard to safety and radiation protection. Motivations of the presented reference design and methods as the best available are reported elsewhere.

1.3 Interfaces to other reports included in the safety report

The role of the production reports in the safety report is presented in Section 1.2 in the **Repository production report**. A summary of the interfaces to other reports included in the safety report is given below.

1.3.1 The safety report for the long-term safety

By providing a basic understanding of the repository performance on different time-periods, and by the identification of scenarios that can be shown to be especially important from the standpoint of risk, the long-term safety assessment provides feedback to the design of the engineered barriers and underground openings. The methodology used for deriving design premises from the long-term safety assessment is introduced in the **Repository production report**, Section 2.5.2. A more thorough description as well as the resulting design premises are given in the report “Design premises for a KBS-3V repository based on results from the safety assessment SR-Can and some subsequent analyses”, hereinafter referred to as **Design premises long-term safety**. These design premises constitute a basic input to the design of the canister.

As stated in Section 1.2 this report provides information on the initial state of the canister for the long-term safety assessment. This report shall also provide data concerning the design of the canister and the initial state used in the calculations included in the long-term safety assessment.

1.3.2 The safety report for the operational safety

The objectives for the operational safety and radiation protection in the final repository facility and the interim storage and encapsulation plant (Clink) and the general descriptions of the facilities and their main activities given in Chapters 3 and 5 in their operational safety reports constitute input to this report.

Further, the report presenting the safe transport of the encapsulated spent fuel /SKBdoc 1171993/ constitute input to this report.

This report provides information to **SR-operation**, the safety report for Clink and the report on transports of encapsulated spent nuclear fuel on the design of the canister and the technical systems used to seal and inspect it. It also provides information on where and when inspections shall be performed.

1.3.3 The other production reports

The **Repository production report** presents the context of the set of Production reports and their role within the safety report. It also includes definitions of some central concepts of importance for the understanding of the Production reports.

The **Repository production report** sets out the laws and regulations and demands from the nuclear power plant owners applicable for the design of a final repository for spent nuclear fuel. In addition, it describes the safety functions of a KBS-3 repository and how safety is provided by the barriers and their barrier functions. The report goes on to describe how design premises are derived from laws and regulations, owner demands and the iterative processes of design and safety assessment and design and technique development respectively. The starting point for the design premises presented in this report is the barrier functions and design considerations introduced in the **Repository production report**, Chapter 3.

The design and production of the different engineered barriers and underground openings are inter-related. An overview of the design and production interfaces is provided in the **Repository production report**, Chapter 4. The design premises imposed by the canister on the encapsulation of the spent fuel and the design and production of the other engineered barriers are described in this report. These design premises are repeated and verified in the **Spent fuel report** and the “**Engineered barrier**” production reports for which the canister imposes design premises.

1.4 Structure and content

1.4.1 Overview

The general flow of information in the **Canister production report** can be described as follows:

- design premises,
- reference design,
- conformity of the reference design to the design premises,
- manufacturing of the canister,
- encapsulation, transportation, handling and deposition,
- initial state.

The listed bullets are further described in the following sections. In addition, the context of the report is presented in this chapter, and in Appendix B abbreviations and branch terms used in this report are explained.

1.4.2 Design premises

The design premises set out the information required for the design. The design premises for the canister are presented in Chapter 2 of this report. The chapter is initiated with the definition of the canister, its purpose and basic design. After that follows for a presentation of the barrier functions the canister shall provide to contribute to the safety of the final repository and the considerations that shall be made in the design with respect to the application of a well-trying and reliable technique. Finally, the detailed design premises for the canister are given. They state the properties the reference design shall have to maintain the functions and to conform to the design considerations.

1.4.3 Reference design

The description of the reference design comprises the canister components and materials and is presented in Chapter 3. The reference design is specified by a set of variables denominated *design parameters*, e.g. thickness of the copper shell and yield strength of the insert material. The design parameters shall be inspected in the production and acceptable values for them are given for the reference design. The design premises of importance for the design parameters are presented.

1.4.4 Conformity of the reference design to the design premises

An important part of this report is the analyses verifying the conformity of the reference design to the design premises. The conformity to each of the design premises given as feedback from the long-term safety assessment as well as the design premises related to technical feasibility, production and operation is analysed and concluded. The conformity of the reference canister to the design premises is presented in Chapter 4.

1.4.5 Manufacturing of the canister

The presentation of the production of the canister is initiated by an overview comprising:

- requirements on the production and design premises for the development of methods to produce, test and inspect the canister,
- illustration of the main parts and different stages of the production,
- short descriptions of the reference methods for production, test and inspection,
- overview of the design parameters and the corresponding parameters measured in the production to inspect them, and in which stage of the production the design parameters are processed and inspected.

After that follows descriptions of each stage in the production and how the design parameters are processed, tested and inspected within each stage. The current experiences and results from each main part of the production are summarised. The manufacturing of the canister is presented in Chapter 5.

1.4.6 Encapsulation, transportation, handling and deposition

An overview of the delivery assembled canisters and how the encapsulation of the spent nuclear fuel and the transportation, handling and deposition of the canister with spent nuclear fuel are performed within the KBS-3 system is provided in Chapter 6. The chapter also describes the inspections that shall be performed in the different stages of the encapsulation, transports, handling and deposition.

1.4.7 Initial state of the canister

In Chapter 7, the initial state chapter, the expected values of the design parameters, and other parameters required for the assessment of the long-term safety, at the initial state are presented. The expected values are based on the current experiences from the production trials, and they are discussed and justified with respect to the currently available results. Finally, the conformity of the canister at the initial state to the design premises stated in **Design premises long-term safety** is summarised.

2 Design premises for the canister

In this chapter, the design premises for the canister are presented. They comprise the barrier functions and properties the canister shall sustain in the KBS-3 repository and premises for the design. *The required functions and design premises are written in italics.*

2.1 General basis

2.1.1 Identification and documentation of design premises

The methodology to derive, review and document design premises is presented in the **Repository production report** Chapter 2. The design premises are based on:

- international treaties, national laws and regulations,
- the functions of the KBS-3 repository,
- the safety assessment,
- technical feasibility,
- the planned production.

The **Repository production report**, Section 2.2 includes a presentation of the laws and regulations applicable for the design of a final repository for spent nuclear fuel. Based on the treaties, laws and regulations SKB has identified functions and considerations as a specification of the KBS-3 repository, and as guidelines for the design of its engineered barriers and underground openings. In Section 3.3.2 of the **Repository production report** the barrier functions and properties the canister shall sustain in order to contribute to the functions of the KBS-3 repository are presented. Section 3.9 of the **Repository production report** introduces the design considerations to be applied in the design work. The presented barrier functions of the canister and the considerations that shall be applied in the design work are repeated in Section 2.2 in this report.

The design premises related to the barrier functions of the canister in the KBS-3 repository are based on the results from the latest performed long-term safety assessment and some subsequent analyses. These design premises for the canister are provided in **Design premises long-term safety**, and are presented in Section 2.3.1 in this report.

Design premises related to technical feasibility refer to the properties the canister shall have to fit together with the spent nuclear fuel, and the engineered barriers of the final repository during the production. The general approach to substantiate this kind of design premises is presented in Section 2.5.1 in the **Repository production report** and the interfaces to the engineered barriers and other parts in the production are summarised in Section 4.4.2 in the **Repository production report**. In this report, these design premises for the canister are presented in Sections 2.3.2 and 2.3.3. In Section 2.4 the design premises the canister impose on other parts of the KBS-3 repository are presented.

The canister contributes to the safety during transportation and is a barrier in the final repository facility during operation. The methodology to substantiate design premises related to the safety of the final repository facility during operation is presented in Section 2.5.5 in the **Repository production report**. There are also design premises related to the reference methods for manufacturing and inspection. The design premises related to the operation of the KBS-3 repository facility and the production of the canister are presented in Section 2.3.4 in this report.

2.1.2 Definition, purpose and basic design

The canister is one of the engineered barriers in the KBS-3 repository. The canister is a container with a tight copper shell and a load-bearing insert in which spent nuclear fuel is placed for deposition in the KBS-3 repository. The canister shall contain the spent nuclear fuel and prevent the release of radionuclides into the surroundings. The canister shall also shield radiation and prevent criticality.

The canister is also a barrier, i.e. a physical confinement of radioactive substances, in the final repository facility during operation and a confinement during transports of the encapsulated spent nuclear fuel.

The canister is cylindrical. All canisters have the same external dimensions. The reason for this is to facilitate, and thereby make the handling of the canister cost-effective, safe and reliable. Further, BWR and PWR assemblies are not mixed in the same canister. As a consequence, there are two versions of the insert, one adapted to the dimensions of the BWR assemblies and one adapted to the PWR assemblies. The number of assemblies is twelve in a BWR insert and four in a PWR insert.

Further, the design premises for the canister provide that the insert is made of cast iron and that the copper shell is sealed by welding.

2.2 Barrier functions and design considerations

In this section, the barrier functions and design considerations for the canister are presented. They are based on the functions of the KBS-3 repository presented in Section 3.1.2 of the **Repository production report** and are divided into:

- barrier functions and properties the canister shall sustain in order for the final repository to maintain its safety (Section 2.2.1),
- issues that shall be considered when developing a canister design and methods for manufacturing, deposition and inspection (Section 2.2.2).

2.2.1 Barrier functions in the KBS-3 repository and functions in the facilities

The KBS-3 repository shall accommodate all spent nuclear fuel from the currently approved Swedish nuclear power programme. This means that the canister shall:

- *contain the various types of spent nuclear fuel that results from the currently approved Swedish nuclear power programme.*

In order for the KBS-3 repository to contain, prevent or retard the dispersion of radioactive substances, the canister shall:

- *contain the spent nuclear fuel and prevent the dispersion of radioactive substances,*
- *withstand the mechanical loads that are expected to occur in the final repository,*
- *withstand the corrosion loads that are expected to occur in the final repository.*

In order for the KBS-3 repository to maintain the multi-barrier principle and have several barriers, which individually and together contribute to maintain the barrier functions, the canister:

- *must not significantly impair the barrier functions of the other barriers,*
- *shall prevent criticality.*

After the canister is sealed, it shall contain the spent nuclear fuel and prevent criticality also in the facilities and the transport system included in the KBS-3 system. Furthermore, with respect to the safe operation of the KBS-3 system it shall be possible to:

- *transport, handle and deposit the canister in a safe way without significantly affecting the properties of importance for the barrier functions in the final repository.*

The final repository facility shall be accessible for and be provided with necessary means for the inspection of nuclear material. With respect to this, the following is stated for the design of the canister.

- *In the control of nuclear material, each sealed canister shall represent a reporting unit.*

2.2.2 Design considerations

In this section, the design considerations that shall be regarded in the design of the canister and in the development of methods to manufacture, handle, test and inspect the canister and its components are presented. The design considerations mainly affect the development of methods. When a reference design is determined it together with the design considerations form the basis for the detailed requirements on methods to manufacture, test and inspect the canister presented in Section 5.1.3.

The system of barriers and barrier functions of the final repository shall withstand failures and conditions, events and processes that may impact their functions. Hence the following shall be considered.

- *The canister design and methods for manufacturing, inspection, transportation, handling and deposition shall be based on well-tried or tested techniques.*

The construction, manufacturing, deposition and inspections of the barriers within the final repository shall be dependable, and the following shall be considered.

- *Canisters with specified properties shall be possible to manufacture, transport, handle and deposit with high reliability.*
- *The properties of the canister shall be possible to inspect against specified acceptance criteria .*

A reliable production is also required with respect to SKB's objective to achieve high quality and cost-effectiveness. Regarding cost-effectiveness, the following shall be considered.

- *The canister design and methods for manufacturing, transportation, handling, deposition and inspection, shall be cost-effective.*
- *It shall be possible to manufacture and inspect canisters at the prescribed rate.*

Further, environmental impact such as noise and vibrations, emissions to air and water and consumption of material and energy shall be considered in the design. Methods to manufacture, inspect, handle and deposit the canister must also conform to regulations for occupational safety. Design premises related to these aspects can generally be met in alternative ways for canister designs that conform to the safety and radiation protection design premises. Together with requirements on efficiency and flexibility they are of importance for the design of technical systems and equipment used in the production of the canister. The design of the technical equipment is not discussed in this report.

2.3 Design premises

In this section the design premises for the canister are given. They constitute a specification for the design of the canister. The design premises comprise the properties and parameters to be designed and premises for the design such as quantitative information on features, performance, events, loads, stresses, combinations of loads and stresses and other information, e.g. regarding environment or adjacent systems, which form a necessary basis for the design.

The design premises are based on the required barrier functions presented in Section 2.2.1 and the design considerations presented in Section 2.2.2. They are also based on, and constitute a concise summary of, the current results of the design process with its design-safety assessment and design-technical feasibility iterations, see Section 2.5 in the **Repository production report**.

The design premises given as feedback from the long-term safety assessment are compiled in **Design premises long-term safety**.

The design premises given as feedback from the technical development are based on the reference designs of the other parts of the KBS-3 repository, and on the planned handling of the sealed canister within the KBS-3 system as summarised in the **Repository production report**, Section 4.1.4. In addition, the properties of the spent nuclear fuel will provide design premises for the canister.

2.3.1 Design premises related to the barrier functions in the KBS-3 repository

The design premises related to the barrier functions in the KBS-3 repository are compiled in Table 2-1. In the leftmost column the required barrier functions presented in Section 2.2.1 are repeated, the middle column contains the canister properties and design parameters to be designed and in the rightmost column the design premises as stated in **Design premises long-term safety** are given.

2.3.2 Design premises from the spent fuel

The premises for the design of the canister from the spent nuclear fuel are compiled in Table 2-2. In the leftmost column the required functions presented in Section 2.2.1 are repeated, the middle column contains the canister properties and design parameters and in the rightmost column the design premises from the spent nuclear fuel are presented.

2.3.3 Design premises from the other engineered barriers and underground openings

There are no design premises imposed by the other engineered barriers or underground openings on the canister.

2.3.4 Design premises related to the production and operation

In this section the design premises for the canister related to its production and the operation of the facilities and transport system of the KBS-3 system are given, see Table 2-3. In addition to the required functions and design considerations presented in Sections 2.2.1 and 2.2.2, they are based on the current results from the technical development of methods to manufacture the canister and the planned handling of the canister.

2.4 Design premises imposed by the canister

In this section, the design premises imposed by the canister on:

- the handling of the spent nuclear fuel,
- the other engineered barriers,
- and the facilities and transport system of the KBS-3 system are presented.

These design premises are further discussed and verified in the **Spent fuel report**, the **Buffer production report** and the safety reports of the facilities in the KBS-3 system and the assessment of the safety during transports.

2.4.1 Requirements on the handling of the spent nuclear fuel

In this section, the requirements on the handling of the spent fuel assemblies imposed by the canister are stated.

Nitric acid formed from radiolysis of water and air remaining in the canister when it is sealed may cause corrosion of the cast iron insert and the copper shell. Design premises related to this are stated in Table 2-1.

- Design premise: *The amount of nitric acid formed within the insert is limited by changing the atmosphere in the insert from air to > 90% argon. The maximum amount of water left in the insert is set to 600 g.*

Table 2-1. The barrier functions, the related properties and design parameters and the design premises for the canister.

Requirement on canister function (see Section 2.2)	Property and design parameters to be designed	Design premises long-term safety
<i>The canister shall contain the spent nuclear fuel and prevent the dispersion of radioactive substances.</i>	Properties that affect containment. Copper shell – dimensions: <i>tube, lid, base and weld thickness.</i>	<i>A nominal copper thickness of 5 cm, also considering the welds.</i>
<i>The canister shall withstand* the corrosion loads that are expected to occur in the final repository.</i>	Properties that affect containment. Copper shell – dimensions: <i>tube, lid, base and weld thickness.</i>	<i>A nominal copper thickness of 5 cm, also considering the welds.</i>
	Properties that affect copper corrosion resistance. Copper shell – material composition: <i>copper quality and oxygen content.</i>	<i>The copper material should be highly pure copper to avoid corrosion coupled to grain boundaries. Oxygen contents of up to some tens of ppm can, be allowed.</i>
	Properties that affect the radiation dose rate at the canister surface, see Table 2-2.	<i>Corrosion due to formation of nitric acid is analysed and neglected for radiation dose rates less than 1 Gray/h.</i>
<i>The canister shall withstand* the mechanical loads that are expected to occur in the final repository.</i>	Properties that affect the strength of the insert. Insert – material properties: <i>compression yield strength, fracture toughness (K_{Ic}).</i> Insert – dimensions: e.g. <i>edge distance.</i> Properties that affect the creep ductility of the copper shell. Copper shell – material properties: <i>elongation, creep ductility.</i>	<i>The canister shall withstand an isostatic load of 45 MPa, being the sum of maximum swelling pressure and maximum groundwater pressure.</i>
	Properties that affect the insert pressure bearing capacity. Insert – material properties: <i>tensile yield strength, fracture toughness (J_{2mm}).</i> Insert – dimensions. Properties that affect the creep ductility in the copper shell. Copper shell – material properties: <i>elongation, creep ductility.</i>	<i>The copper corrosion barrier should remain intact after a 5 cm shear movement at a velocity of 1 m/s for buffer material properties of a 2,050 kg/m³ Ca-bentonite, for all locations and angles of the shearing fracture in the deposition hole, and for temperatures down to 0°C. The insert should maintain its pressure-bearing properties to isostatic loads.</i>
	Properties that affect the insert hardness and brittleness. Insert – material composition: <i>copper content.</i>	<i>Gamma radiation causes hardness and brittleness in cast iron. The copper content in cast iron is < 0.05%</i>
	Properties that affect the creep ductility and embrittlement of the copper shell. Copper shell – material composition: <i>phosphorus, sulphur and hydrogen content.</i> Copper shell – material properties: <i>average grain size.</i>	<i>The properties of the copper material are upheld providing the content of other elements are limited.</i> <i>Creep ductility:</i> – phosphorus 30–100 ppm, – sulphur < 12 ppm, – average grain size < 800 µm. <i>Embrittlement:</i> – hydrogen < 0.6 ppm.
	Enable a change of atmosphere in the insert and ensure the insert lid tightness before sealing of copper shell. Insert – details: <i>steel lid valve, steel lid gasket and milled notches.</i>	<i>The quantity of nitric acid that can be formed in the insert is limited if the atmosphere inside the insert is replaced by > 90% argon. Analysed so that the maximum permissible quantity of water in the insert is 600 g.</i>
	Details in the canister material composition and dimensions affecting the propensity for criticality of the fuel assemblies, see Table 2-2.	<i>The spent fuel properties and geometrical arrangement in the canister should further be such that criticality is avoided even if water should enter a canister.</i>

* Withstand – The statement that a component withstands a particular load means that it upholds its related safety function when exposed to the load in question, see Section 1.2 in **Design premises long term safety**.

Table 2-2. The functions, the related properties, design parameters and the design premises from spent fuel for the canister.

Requirement on function	Property and design parameters to be designed	Design premises from the spent fuel
<i>The canister shall contain the various types of spent nuclear fuel that results from the currently approved Swedish nuclear power programme.</i>	<i>Dimensions of the fuel channel tubes of the insert shall be adapted to the dimensions of the spent fuel to be deposited.</i> Insert – channel tube length and cross section.	<i>The length of the longest BWR or PWR assembly, including induced length increase. The cross section of the largest BWR and PWR fuel assemblies, including deviations due to deformations during operation.</i> Longest assembly: 4,455 mm (BWR). Largest cross section: BWR assembly: 145.5×145.5 mm. PWR assembly: 228×228 mm.
<i>The canister shall prevent criticality.</i>	Details in the canister material composition affecting the propensity for criticality of the fuel assemblies. Insert – material composition (Fe, C, S). Insert – distance between channel tubes.	<i>To prevent criticality the material composition of the nodular cast iron shall be:</i> Fe > 90%, C < 6% and Si < 4%
<i>The canister shall withstand* the corrosion loads that are expected to occur in the final repository.</i>	Properties that affect the radiation dose rate at the canister surface. Copper shell dimensions: Tube and weld thickness. Insert dimensions: edge distance.	<i>Radionuclide inventory of assemblies selected for encapsulation.</i>
<i>In the control of nuclear material each sealed canister shall represent a reporting unit.</i>	Copper shell: labelling.	<i>The canister shall be marked with a labelling which shall be unique and readable after sealing, machining and deposition of the canister.</i>

* Withstand – The statement that a component withstands a particular load means that it upholds its related safety function when exposed to the load in question, see Section 1.2 in **Design premises long term safety**.

Table 2-3. The functions and design considerations, the related properties and design parameters and the design premises from facilities for the production of the canister.

Requirement on function/ design consideration	Property and design parameters to be designed	Design premises
<i>Canisters with specified properties shall be possible to manufacture, transport, handle and deposit with high reliability.</i>	Properties that affect the possibilities to lift and handle the canister. Copper shell – dimensions: lid flange dimensions.	<i>The canister shall allow to be lifted by its lid during handling in the facilities.</i> <i>The canister shall allow deposition with respect to all events that are expected to occur during the lifetimes of the facilities of the KBS-3 system*.</i>
<i>The properties of the canister shall be possible to inspect against specified acceptance criteria.</i>	Properties that affect the possibilities to inspect the sealed canisters. Copper shell – material properties: average grain size.	<i>To allow ultrasonic testing the average grain size shall be less than 360 µm.</i>

* The highest stresses occur during an unplanned stoppage during canister lowering /SKBdoc 1191524/.

As a consequence, the following requirements on the handling of the spent fuel assemblies are imposed by the canister.

- Requirement on the handling: *Before the fuel assemblies are placed in the canister, they shall be dried so that it can be justified that the accepted amount of water stated as a design premise for the canister is not exceeded.*
- Requirement on the handling: *Before the canister is finally sealed, the atmosphere in the insert shall be changed so that acceptable chemical conditions can be ensured.*

With respect to criticality the following design premise is stated in Table 2-1:

- Design premise: *The spent fuel properties and geometrical arrangement in the canister should be such that criticality is avoided even if water should enter a canister.*

With respect to this, the canister imposes the following requirement on the handling of the spent fuel:

- Requirement on the handling: *The fuel assemblies to be encapsulated shall be selected with respect to enrichment, burnup, geometrical configuration and materials in the canister, so that criticality will not occur during the handling and storage, even if the canister is filled with water.*

Corrosion of the copper shell in the repository due to formation of nitric acid can be neglected if the radiation dose rate at the canister surface is limited, and the following design premise is stated in Table 2-1.

- Design premises: *Corrosion due to formation of nitric acid is analysed and neglected for radiation dose rates less than 1 Gray/h.*

The radiation dose rate at the canister surface will depend both on the canister design and the radioactivity of the spent nuclear fuel. This design premise shall be verified for the reference design of the canister and the fuel assemblies selected for encapsulation, and the following requirement is stated for the handling of the fuel assemblies:

- Requirement on handling: *It shall be verified that the radiation dose rate on the canister surface will not exceed the level used as a premise in the assessment of the long-term safety.*

2.4.2 Design premises for the other barriers

In this section, the design premises imposed by the canister on the other engineered barriers in order to achieve a technically feasible design and reliable production process are presented (not included in Table 2-1). Related to technical feasibility the canister only provides design premises for the buffer.

Buffer

The buffer shall allow the canister to be deposited without causing damages that significantly impair the barrier functions of the canister or buffer. With respect to this, the following is stated for the design of the buffer. *The installed buffer shall contain a hole centred with respect to the vertical centre line of the deposition hole and large enough to allow deposition of the canister without impairing the canister or buffer.*

- Design premises: *The outer dimensions of the reference canister, see Table 3-6.*

2.4.3 Design premises for the facilities and the transportation system of the KBS-3 system

SKB has stated that the canister shall be fit for deposition for all conditions encountered included in the normal operation of the facilities and transport system of the KBS-3 system. With respect to this and the requirement that *it shall be possible to transport, handle and deposit the canister in a safe way without affecting the properties of importance for the barrier functions in the final repository*, the following design premise is stated for the facilities and transport system of the KBS-3 system.

- Design premise: *The temperature on the surface of the copper shell must not exceed 100°C.*

It is based on the statement in **Design premises long-term safety** that *in order to prevent thermal processes from impairing the mechanical properties of the canister material the copper shell and the insert must not be exposed to temperatures substantially above 100°C. For higher temperatures (i.e. above 125°C) the materials need to be further assessed.*

The background is mainly that the influence of high temperatures, above 100°C, on the mechanical properties of canister materials has not been investigated. If the temperature is kept below these limits, thermally induced changes in the material structures can be neglected. This is in principle also a design premise imposed by the canister on the buffer and underground openings; however since there is a restriction on the highest accepted temperature in the buffer, see **Buffer production report** Section 2.3.1, the temperature will conform to this design premise after deposition.

Further, *the canister must not be exposed to mechanical impact that result in damages on the copper shell that significantly impair its barrier functions.* Results from the analyses of the conformity of the reference design of the canister to the design premises (Section 4.3.2) indicates that further experimental studies and modelling of the effects from indentations and local plastic strain are required to better assess this kind of damages and, if required, develop acceptance criteria /Raiko et al. 2010/.

In addition, *the canister must not be exposed to chemical impact resulting in significant corrosion of the copper shell.* This implies that systems to control the management of chemicals in the facilities have to be established.

Lifting and handling equipment for the canister used in the facilities and the canister transport cask (KTB, see Section 6.5) shall be designed to conform to these design premises. These design premises shall also be considered in the instructions for handling the canister in the facilities and during transportation. The required inspections are further described in Chapter 6.

3 Canister reference design

The reference design specifies the current design of the canister. The reference design shall conform to the design premises presented in Chapter 2. Further, the reference design shall be demonstrated as technically feasible to produce and handle by the methods for production presented in Chapter 5 and the methods applied for encapsulation, transportation and deposition presented in Chapter 6.

The canister reference design is not necessarily optimised, and SKB may at a later stage decide to make changes to it provided that it can be demonstrated that the new design conforms to the design premises.

The reference design is described by a set of *design parameters* for which nominal values and acceptable variations are given. An example of a design parameter is the copper shell thickness.

The verification of the reference design shall demonstrate the conformity of the reference canister to the design premises. The design parameters shall be inspected in the production to verify that the delivered canister conforms to the reference design. This can be done, for example, by inspection of the material composition or ultimate strength and by qualifying manufacturing processes. If the canisters are manufactured, handled and deposited such that their properties when deposited lie within the specification of the reference design, the deposited canisters conform to the design premises.

In summary, the current reference design of the canister consists of a tight corrosion barrier of copper and a load-bearing insert of nodular cast iron, see Figure 3-1.

The reference canister design comprises two different inserts, one for 12 BWR fuel assemblies and one for 4 PWR fuel assemblies. Figure 3-2 shows the differences between the two. Miscellaneous fuels, e.g. fuel assemblies from Ågesta, swap MOX assemblies (both BWR and PWR) and fuel residues in special boxes from Studsvik as described in Section 2.2 of the **Spent fuel report**, can be accommodated in these canister designs.



Figure 3-1. SKB's reference canister with an outer corrosion barrier of copper and an insert of nodular cast iron.

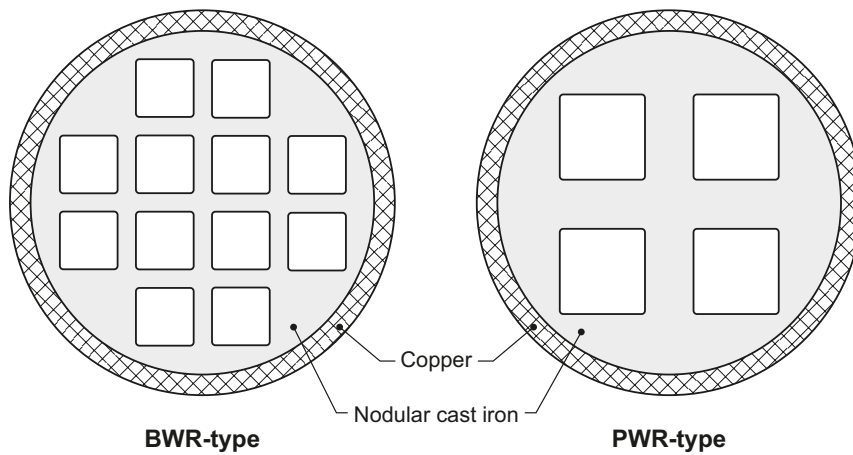

Figure 3-2. Basic differences between the BWR and PWR canister design.

The maximum total weight of the canister, including fuel, is 24,700 kg for BWR and 26,800 kg for PWR, see Table 3-1.

The canister comprises the following components which are detailed in the following sections: cast iron insert with steel tube cassette, steel lid, copper tube, copper lid and copper base, see Figure 3-3.

3.1 Insert

The insert is manufactured of nodular cast iron with steel channel tubes in which the fuel assemblies are to be positioned. The channel tubes are made from square profiled steel tubes which are welded together to form a steel tube cassette which is placed in the casting mould.

Table 3-1. Weight of the canisters.

	Weight (kg)	
	BWR-canister	PWR-canister
Insert with lid	13,700	16,400
Copper shell	7,500	7,500
Canister without fuel	21,200	23,900
Canister with fuel	24,600–24,700	26,500–26,800



Figure 3-3. Exploded view of the reference canister and its components (from the left: copper base, copper tube, insert, steel lid for insert and copper lid).

3.1.1 Material composition

To avoid gamma irradiation induced hardening and embrittlement in the cast iron the:

- copper content in nodular cast iron shall be $< 0.05\%$ (see Table 2-1).

To ensure that that criticality will not occur:

- iron content in nodular cast iron shall be $> 90\%$,
- carbon content in nodular cast iron shall be $< 6\%$,
- silicon content in nodular cast iron shall be $< 4\%$.

3.1.2 Material properties

The governing material properties for the strength of the insert are the mechanical properties of the nodular cast iron and the steel lid. The material properties of the cast iron are mainly defined by a stress-strain curve. The properties of the nodular cast iron of importance for the insert are the compression yield strength and fracture toughness (K_{Ic}) at isostatic loads and tensile yield strength and fracture toughness (J_{2mm}) at shear loads. Fracture toughness is a property that describes the ability of a material containing a crack to resist fracturing.

At this stage of the production, the nodular cast iron in the insert and the structural steel in the lid shall meet the minimum specifications for strength and ductility stipulated in Table 3-2. The given data is based on material testing of manufactured BWR inserts. The same data is used for analyses of PWR inserts as representative data from PWR inserts remain to be determined.

3.1.3 Dimensions

The dimensions of the cast iron insert with the steel lid are given in the figures and tables below. All dimensions are specified at room temperature, 20°C.

The given dimensions for the insert are used either as input to verifying analyses of the canister strength or analysis of prevention of criticality. A critical dimension for the strength of the reference canister is the edge distance. The distance between the channel tubes is important for criticality.

To facilitate replacement of the atmosphere in the insert the steel lid has a valve and there are milled notches in the insert top, a notch is shown in Figure 5-4. In addition, the steel lid has a gasket to ensure a gas tight seal.

Table 3-2. Minimum strength and ductility for nodular cast iron and structural steel for steel lid.

Design parameter	Cast nodular iron	Structural steel in steel lid
Yield strength (MPa)	> 267 (in tension, true stress) > 270 (in compression, true stress)	> 335 (tension, engineering stress)
Ultimate strength (MPa)	> 480 (in tension)	> 470
Fracture toughness in 0°C	$J_{2mm} > 88$ kN/m (lower 90% confidence) $J_{1c} > 33$ kN/m (lower 90% confidence) $K_{Ic} > 78$ MPa (m) ^{1/2} (lower 90% confidence)	–
Elongation ¹ (%)	> 12.6 (lower 90% confidence)	–

¹ mainly used as quality check.

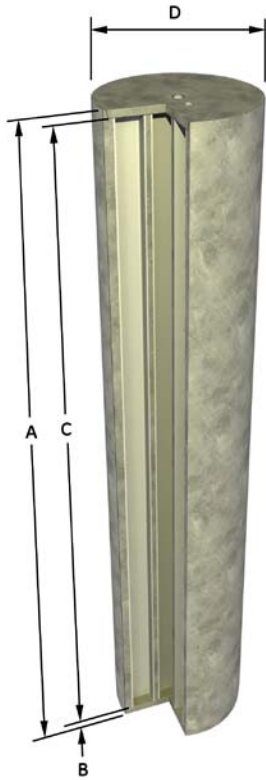

Figure 3-4. Insert dimensions, see Tables 3-3, 3-4 and 3-5.

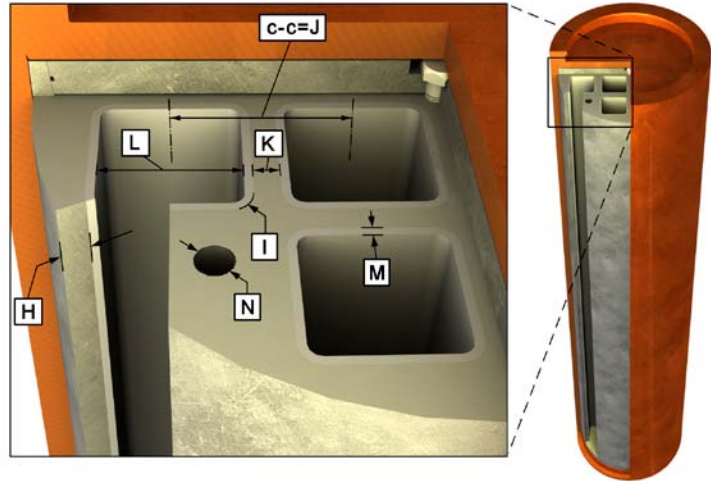

Figure 3-5. Insert channel tubes with dimensions, see Table 3-4 and 3-5.

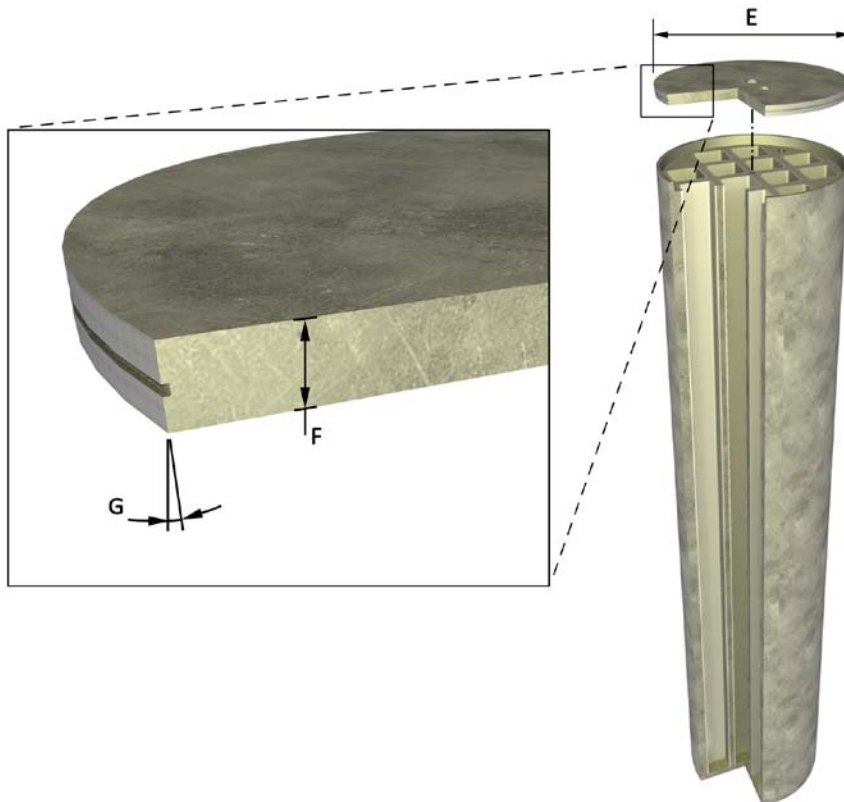

Figure 3-6. Steel lid dimensions, see Table 3-3.

Table 3-3. Common dimensions for BWR- and PWR-insert /SKBdoc 1203875/.

Figure no and dimension designation	Designation	Nominal value (mm)	Tolerance (mm)
Insert common dimensions			
3-4 A	Length of insert	4,573	+0/-0.5
3-4 D	Insert diameter	949	+0.5/-0
Steel lids			
3-6 E	Diameter	910	h7
3-6 F	Lid thickness	50	+0.1/-0.1
3-6 G	Bevel angle	5°	+0.1°/-0.1°

Table 3-4. Dimensions for BWR-inserts /SKBdoc 1203875/.

Figure no and dimension designation	Designation	Nominal value (mm)	Tolerance (mm)
BWR-Inserts			
3-4 B	Thickness of bottom	60	+10.1/-5.6
3-4 C	Interior length	4,463	+5/-10
3-5 H	Edge distance	33.3	+10/-10
3-5 N	Lifting eye holes	Two holes with M45, thread length 75 mm and drill depth 90 mm	
BWR-Insert channel tubes			
3-5 I	Ext. channel tube corner radius	20	+5/-5
3-5 K	Distance between channel tubes	30	+2.7/-4.6
3-5 J Calculated	C-C distance between compartments	210	+1/-4
3-5 L Calculated	Int. channel tube cross section (before casting)	160×160	+3.8/-3.8*
3-5 M	Channel tube thickness	10	+1/-1
3-5	Ext. channel tube cross section	180	+1.8/-1.8

* This tolerance of inner cross section of channel tube is valid before casting.

Table 3-5. Dimensions for PWR-inserts /SKBdoc 1203875/.

Figure no and dimension designation	Designation	Nominal value (mm)	Tolerance (mm)
PWR-Inserts			
3-4 B	Thickness of bottom	80	+10.1/-5.6
3-4 C	Interior length	4,443	+5/-10
3-5 H	Edge distance	37.3	+10/-10
3-5 N	Lifting eye holes	Two holes with M45, thread length 90 mm and drill depth 100 mm	
PWR-Insert channel tubes			
3-5 I	Ext. channel tube corner radius	20	+5/-5
3-5 K	Distance between channel tubes	110	+6.2/-6.2
3-5 J Calculated	C-C distance between compartments	370	+3.6/-3.6
3-5 L Calculated	Int. channel tube cross section (before casting)	235×235	+5.1/-5.1*
3-5 M	Channel tube thickness	12.5	+1.25/-1.25
3-5	Ext. channel tube cross section	260	+2.6/-2.6

* This tolerance of inner cross section of channel tube is valid before casting.

3.2 Copper components and weld

In order to conform to the design premises regarding the corrosion loads, the copper shell, i.e. tube, lid and base, are made of highly pure copper. The copper components are welded together by friction stir welding (FSW). To facilitate handling of the canister, the copper lid is provided with a flange to allow handling equipment to grip the canister.

3.2.1 Material composition

For the highly pure copper (> 99.99%) the following specifications shall apply (see Table 2-1).

- To obtain the required creep ductility:
 - Phosphorus 30–100 ppm,
 - Sulphur < 12 ppm.
- To avoid embrittlement during the manufacturing process:
 - Hydrogen < 0.6 ppm.
- To avoid corrosion coupled to grain boundary corrosion:
 - Oxygen content up to some tens of ppm.

3.2.2 Material properties

In order for the copper shell to withstand the mechanical loads in the final repository, it shall have the following properties:

- elongation > 40%,
- creep ductility > 15%,
- average grain size < 800 μm (verified maximum grain size that still gives sufficient creep ductility).

To facilitate ultrasonic testing of the copper shell, the following preliminary limit has been set for the average grain size:

- average grain size < 360 μm .

3.2.3 Dimensions

The copper shell shall provide a sufficient corrosion barrier and withstand the anticipated mechanical loads in the final repository. During the handling within the KBS-3 system the dimensions of the shell shall be sufficient to ensure that it provides containment over a long period of time. The dimensions are given in the figures and tables below. All dimensions are specified at room temperature, 20°C.

The given dimensions for the copper components have been used as input data to verifying analyses of the canister or as design premises for the design of other barriers and systems to handle the canister e.g. the outer dimensions of the canister.

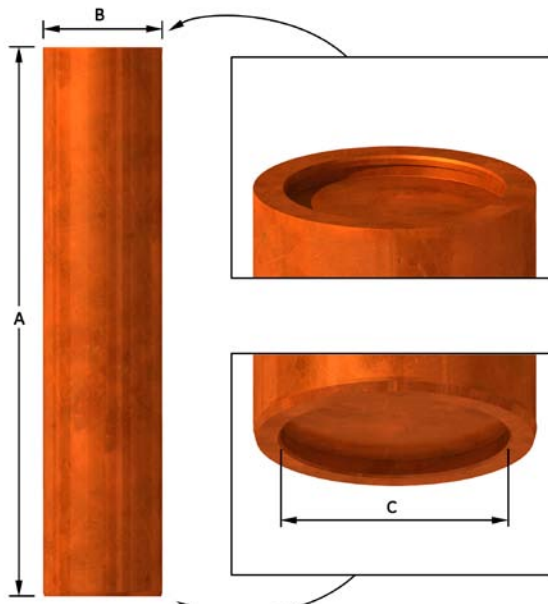

Figure 3-7. Copper shell dimensions, see Table 3-6.

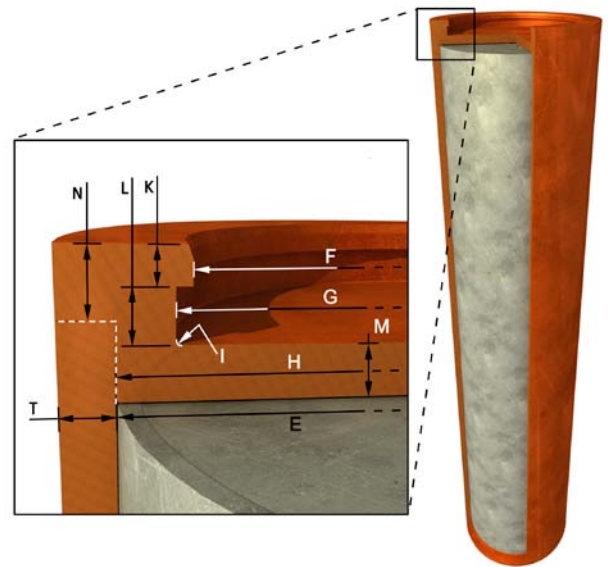

Figure 3-8. Copper lid dimensions, see Table 3-6.

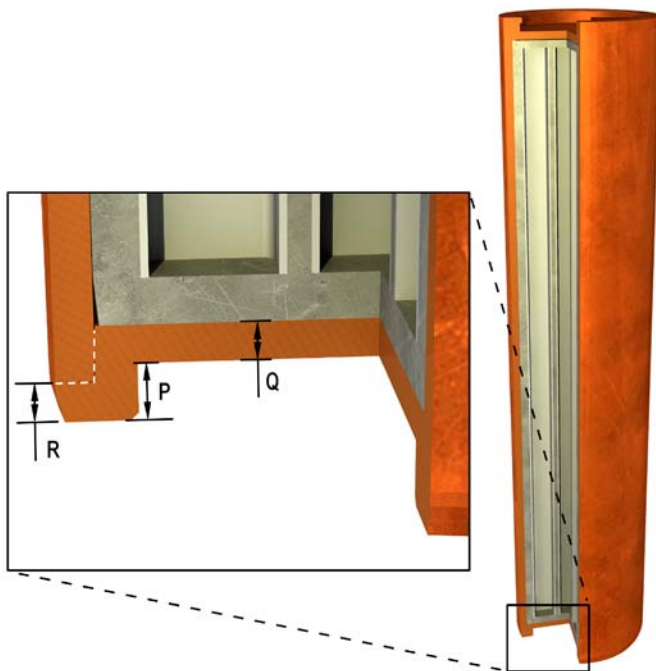

Figure 3-9. Copper base dimensions, see Table 3-6.

Table 3-6. Dimensions for copper shell /SKBdoc 1203875/.

Figure no and dimension designation	Designation	Nominal value (mm)	Tolerance (mm)
Copper shell			
3-7 A	Total length	4,835	+3.25/-2.75
3-7 B	Outer diameter	1,050	+1.2/-1.2
3-7 C	Inner diameter	850	+0.8/-0.8
3-8 T	Wall thickness	49	+0.3/-0.3
	Weld thickness*	48.5	+0.7/-0.7
3-8 E	Inner diameter	952	+0.5/-0.5
3-8 F	Inner diameter	821	+0/-0.5
3-8 G	Inner diameter	850	+0.8/-0.8
3-8 H	Diameter, lid	953	d8
3-8 H	Diameter, tube	953	H8
3-8 I	Corner radius	10	-
3-8 K	Dimension	35	+0.5/-0.5
3-8 L	Dimension	50	+0.2/-0.2
3-8 M	Thickness, lid	50	+0.6/-0.6
3-8 N	FSW position top	60	-
3-9 P	Dimension	75	+0.3/-0.3
3-9 Q	Thickness, base	50	+1/-1
3-9 R	FSW position base	50	-
Calculated	Inner free length	4,575	+0.6/-0.1
Calculated	Axial gap between steel and copper lids	2	+1.1/-0.3
Calculated	Radial gap between shell and insert	1.5	+0.25/-0.5

* The weld thickness differs from the wall thickness since the copper tube surfaces that connect to the lid and base respectively are further machined.

4 Conformity of the reference design to the design premises

This chapter summarises the performed analyses and measures taken to verify that the reference canister conforms to the design premises described in Chapter 2. The major reference to this chapter is a design analysis /Raiko et al. 2010/ with underlying documentation.

4.1 Structure of the analyses

The objective of the analyses is to verify that the reference canister design, i.e. the material composition, material properties and dimensions of the insert and copper shell accounted for in Sections 3.1 and 3.2 conforms to the design premises presented in Section 2.3. The relevant design premises are:

- related to the barrier functions in the KBS-3 repository,
- from the spent nuclear fuel,
- from the other engineered barriers,
- related to the production and operation.

Design premises related to the barrier functions in the KBS-3 repository are stated in Table 2-1 in Section 2.3.1. In summary, this section describes how the following shall be verified for the reference canister.

- The canister withstands an isostatic load of 45 MPa, being the sum of maximum swelling pressure and maximum groundwater pressure.
- The corrosion barrier of the canister remains intact after a 5 cm shear movement at a velocity of 1 m/s for buffer material properties of a 2,050 kg/m³ Ca-bentonite, for all locations and angles of the shearing fracture in the deposition hole, and for temperatures down to 0°C. The insert should maintain its pressure-bearing properties to isostatic loads.
- The canister has a nominal copper thickness of 5 cm to withstand the corrosion loads.
- The spent fuel properties and geometrical arrangement in the canister are such that criticality is avoided even if water should enter a canister.
- Additional design premises for the canister derived from the assessment of the long-term safety.

With respect to the design premises from the spent nuclear fuel it shall be verified that the dimensions of the insert channel tubes are sufficient to accommodate the spent fuel to be deposited and that the canister is marked with a unique identity.

With respect to the production and operation it shall be verified that:

- the canister can be lifted safely by its lid even when it exerts the highest stresses during an unplanned stoppage in canister lowering,
- the average grain size of the copper shell is less than 360 µm to facilitate inspection by ultrasonic testing.

The bases for the analyses performed to verify the above are presented in 4.2. Verifying analyses for the design premises related to the barrier functions stated in Table 2-1 are presented in Sections 4.3–4.8. The conformity to the design premises from the spent fuel and the design premises related to production and operation is presented in Sections 4.9 and 4.10 respectively. Finally, in Section 4.11 the results and conclusions regarding the conformity of the reference design to the design premises stated in Chapter 2 are summarised.

4.2 Conditions for the analyses of mechanical loads

Verifying analyses are carried out based on the reference design described in Sections 3.1 and 3.2 and any exceptions from this are given in connection to the specific load case. The analyses of the mechanical loads are presented in more detail in a design analysis /Raiko et al. 2010/.

4.2.1 Insert

Material properties for the insert used in the analyses are considered representative for manufacturing quality by today's standard and are taken from production trials. The data originate from inserts that have been tested as part of the development of the casting process. Table 4-1 gives a representation of the stress-strain curve that has been used. If any other data has been used this will be specified under the description of that specific load case. The data in Table 4-1 is for tests at room temperature at low strain rate in the order of $5 \times 10^{-4} \text{ s}^{-1}$. The engineering data obtained from the testing has been converted to true values taking into account the axial straining of the specimen and the associated change of the cross section of area of the specimen during testing. Young's modulus (E) used for the nodular cast iron has been set to $E=166 \text{ GPa}$ based on experience and Poisson's ratio (ν) is set to 0.32.

The outcome of the analyses can be influenced by a minor change in the fracture toughness. Because of this the insert material fracture toughness, i.e. the materials ability to withstand a brittle fracture when a crack is present, is considered to be more temperature dependent than the tensile testing data. The fracture toughness has been determined for mode one loading, K_{Ic} , at both room temperature and at 0°C . For load cases where the insert does not behave in a linear-elastic way the J -integral has been used.

All insert data used in analyses have been generated from BWR inserts based on the fact the development of the BWR insert has progressed further than the development of PWR inserts. Data from BWR inserts has also been used for the analyses presented for the PWR insert.

Material properties for the steel lid are based on the steel S355J2G3. In the analyses the material behaviour of the steel is represented by the stress-strain relationship of Domex 355 MC B /SKBdoc 1177857, Section 2.3.1.1/ with yield strength (R_e) = 389 MPa and tensile strength (R_m) = 484 MPa. According to SS-EN 10025 del 2, 2004 the material S355 with nominal thickness 40–63 mm has $R_e = 335 \text{ MPa}$ and $R_m 470\text{--}630 \text{ MPa}$. Therefore, the stress-strain curve for Domex 355 is scaled to fit the minimum values given in SS-EN 10025 del 2. This implies the following simplified material definition (engineering data) given in Table 4-2.

Table 4-1. True tensile stress and true strain values representing the insert material and compression data, as used in the analyses /Raiko et al. 2010/.

Tensile testing data		Compression testing data	
True strain (–)	True stress (MPa)	True strain (–)	True stress (MPa)
0	0	0	0
1.608×10^{-3}	267	1.627×10^{-3}	270
0.02	330	0.02	333
0.04	366	0.04	394
0.06	392	0.06	429
0.10	427	0.10	482
0.15	456	0.20	534

Table 4-2. Stress-strain definition for the insert lid.

Strain (%)	Stress (MPa)
0	0
0.1595	335
15	470
20	470

4.2.2 Copper

Creep in copper has been extensively investigated and the results are summarised in /Andersson-Östling and Sandström 2009, Raiko et al. 2010/ where also the used copper creep material model is described. The model used for the creep analyses presented in this report is called the Φ -model in Figure 4-1(a). Recently a fundamental model, called basic model in Figure 4-1(a), has been derived. However, so far the fundamental model has only been used to a limited extent for Finite Element Modelling (FEM)-computations of creep deformation in canisters. Results using this model are therefore not presented here. Figure 4-1(a) gives the strain versus time curves for both models compared to experimental results at a given stress and temperature.

For analyses of fast processes, such as rock shear analysis and operational handling loads, a simplified elastic-plastic material model has been developed to describe the stress-strain curves of copper /Sandström et al. 2009, Raiko et al. 2010/. The flow curve data can then be calculated and plotted, see Figure 4-1(b). Figure 4-1(b) also includes a comparison with the creep model, the stress giving the same resulting strain rate has been calculated and marked with a cross. The agreement between the models and the presented experiment is good. Values for Young's modulus (E) for copper between 115 and 128 GPa can be found in /Raiko et al. 2010/. A typical value used in calculations is E equals 120 GPa and for Poisson's ratio $\nu=0,308$. Calculations made before the development of the elastic-plastic material model usually use data based on testing of manufactured copper components. Any such data is, if used in this report, presented and described when necessary.

4.3 Isostatic load in the repository

A barrier function of the complete canister is that it shall withstand the isostatic load in the final repository. The design premise in Table 2-1 specified that the isostatic load is 45 MPa being the sum of maximum swelling pressure and maximum groundwater pressure. This is derived from Section 2.2 in **Design premises long term safety** where it is also specified that global collapse is the criterion for canister failure, where global collapse is a severe loss of structural integrity such that the canister's containment functions can no longer be claimed. For the analysis of the isostatic load, the temperature is set to close to 0°C. The highest pressure will occur during glacial periods when the temperature at the ground surface is about 0°C and there is melt water in the interface between the ice sheet and ground surface. All canisters in the repository may be exposed to this pressure which implies that this can be regarded as normal operational conditions in the repository. This implies that safety factors generally applied for normal operation should be used for this load case.

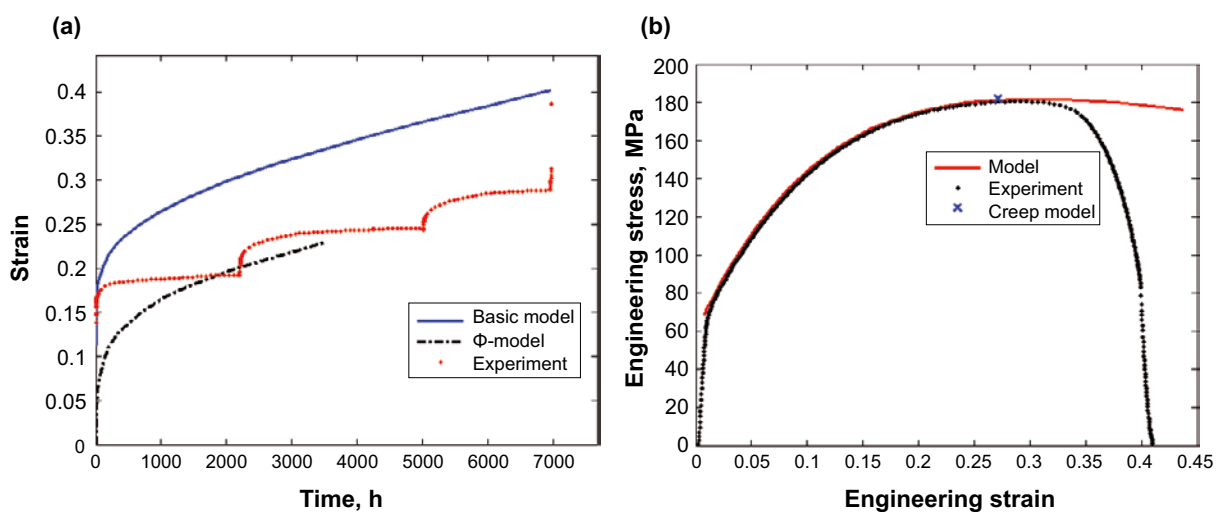

Figure 4-1. Comparison between models and experiment for copper; (a): copper creep models and (b): slow rate tensile testing. The jumps in the left (a) red curve are due to adjustments in the creep rig under the test as the strain was out of range.

4.3.1 Analyses of the insert

The insert strength has been thoroughly analysed deterministically in three main reports using finite element methods (FEM). The different analyses focus on:

- the cylindrical part /Dillström et al. 2010/,
- the insert bottom /SKBdoc 1207429/,
- the steel lid /SKBdoc 1177857/.

In addition, a probabilistic analysis of the insert /SKBdoc 1207426/, as well as pressure tests /Nilsson et al. 2005/ where two shortened canisters were tested has been done. These tests provide further information about the insert strength. A summary of the results is given here and a more comprehensive summary of the analyses is given in /Raiko et al. 2010/.

The analyses of the cylindrical part of the insert includes damage tolerance analyses /Dillström et al. 2010/ for the BWR and PWR inserts, respectively. To simplify the connection between the results of the analyses and the following non-destructive testing (NDT), the inserts have been divided into different zones, Figure 4-2, and maximum acceptable defect size is given for each of the zones. Maximum acceptable defect sizes include a safety factor. The acceptable defect sizes are presented below. In /Dillström et al. 2010/ Appendix N, it is stated that presented results are pessimistic with regard to the data used for yield strength and ultimate tensile strength. This is due to the fact that the development of the casting process has given a material with improved properties compared to the data used in the analyses. It is also stated in Appendix N in the same report that data for fracture toughness at 0°C for newly tested material corresponds closely to the fracture toughness at room temperature for previously tested material. All results given here are therefore valid at repository conditions.

The analysis of the integrity of the bottom was carried out using the same data as used for the cylindrical part of the insert. Dimensions used for the analysis of the bottom were chosen to analyse the least favourable situation. This means that the minimum accepted bottom thickness was used combined with the maximum cross section of area of the channel tubes. All other combinations of dimensions will generate lower stresses and strains in the bottom.

For the analysis of the steel lid the same approach as for the analysis of the bottom was used, i.e. minimum thickness of the lid and maximum cross section of area of the channel tubes.

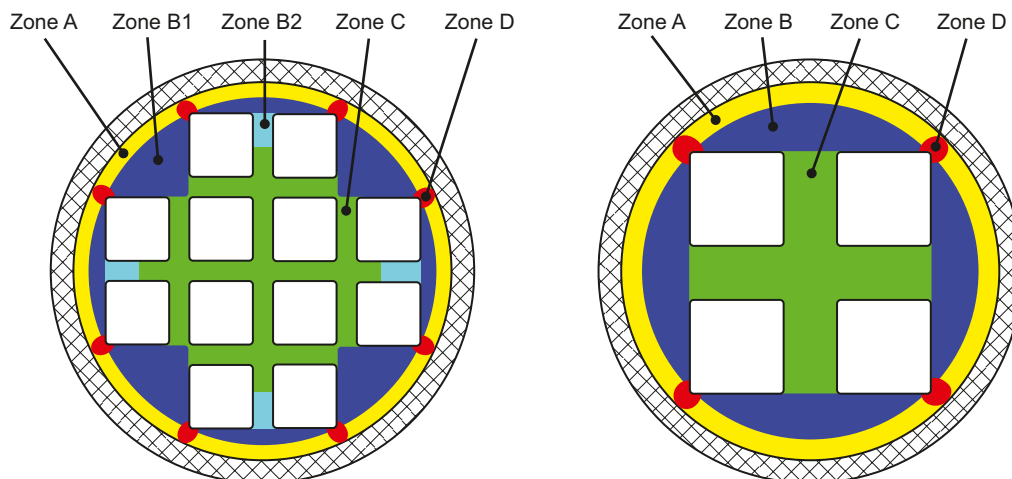

Figure 4-2. Zones in the inserts used for the damage tolerance analysis.

Safety factors

According to nomenclature (ASME) the required limit load is 1.5 times the design pressure, i.e. 67.5 MPa in this case /Raiko et al. 2010/. To analyse the acceptable sizes of crack-like defects safety factors recommended by ASME for analysis of reactor vessels have been used. This has been done by calculating the stress intensity factor K_I in various locations for postulated crack-like defects. The stress intensity was compared with a safety factor of $\sqrt{10}=3.16$ to a reference value of the tested material property K_{Ic} at 0°C temperature. In /Raiko et al. 2010/ it is given that $K_{Ic} = 78 \text{ MPa(m)}^{1/2}$ (lower 90% confidence interval) at this temperature. This gives the margin to brittle failure. The safety factor against plastic collapse for crack-like defects is 2.4. More details are given in /Raiko et al. 2010/.

Results of analyses of the insert

A damage tolerance analysis of the insert was carried out and the result is summarised in Table 4-3 and Table 4-4. All presented defect sizes include a safety factor as described previously. Table 4-3 gives the maximum acceptable defect sizes for postulated semi-elliptical defects according to Figure 4-3 where $2c=6a$. All defect sizes for crack-like defects correspond to 80% of the material thickness at the location of the crack. The reason is that 80% of the material thickness is the maximum defect size that can be analysed for postulated crack-like defects even though the insert might be able to withstand larger defects. For postulated hole defects shaped as cylinders with diameter D and length equal to the length of the canister the maximum acceptable defect sizes are summarised in Table 4-4.

In addition results from /Raiko et al. 2010/ show that an off-set of the steel tube cassette of 10 mm is acceptable, i.e. a 10 mm reduction of the edge distance (measure H in Figure 3-5) compared to the nominal value given in Section 3.1.3 can be accepted with low probability of failure.

In /Raiko et al. 2010/ the result from a probabilistic analysis of the insert is given. This showed that for an insert with nominal geometry and centred steel tube cassette the risk for failure has been calculated to be $< 1 \times 10^{-50}$ in /SKBdoc 1207426/.

The collapse loads for the cylindrical part of a canister with nominal geometry and without defects have been calculated to 99 MPa and 128 MPa for BWR- and PWR-inserts, respectively /Raiko et al. 2010/. Results from pressure tests of canisters are presented in /Raiko et al. 2010/. These test confirm the results from the different analyses and show that the collapse load for the canister is approximately 100 MPa or higher.

Table 4-3. Maximum acceptable sizes for crack-like defects (isostatic load).

Zone (see Figure 4-2)	Defect size a (mm)	
	BWR-insert	PWR-insert
A	37	53
B	65 (B1)	112
	50 (B2)	
C	24	104
D	32	31

Table 4-4. Maximum acceptable sizes for hole defects (isostatic load).

Zone (see Figure 4-2)	Defect size D (mm)	
	BWR-insert	PWR-insert
A	40	80
B	60 (B1)	100
	20 (B2)	
C	20	100
D	20	20

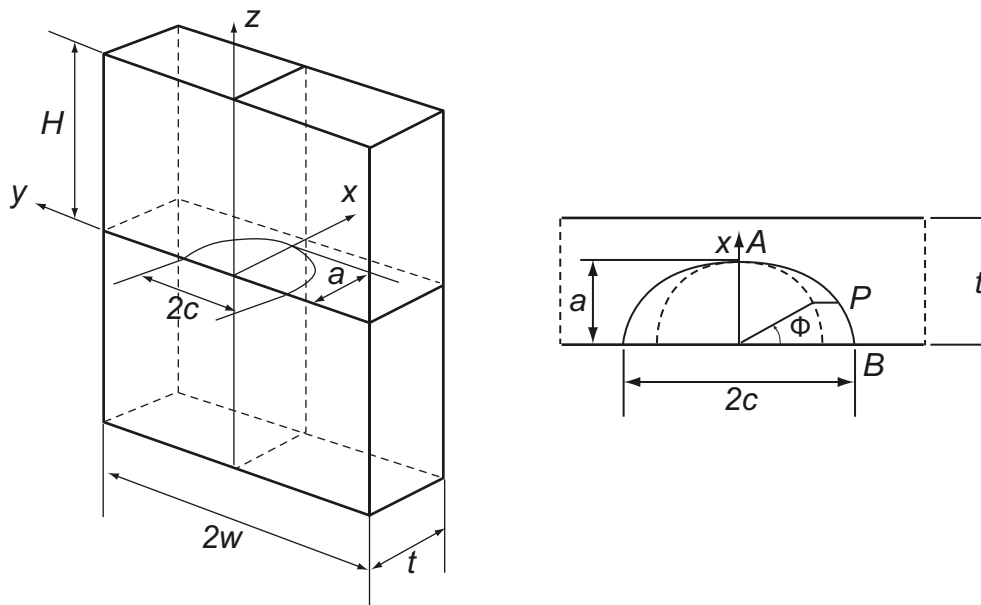

Figure 4-3. Geometry of a postulated semi-elliptical surface crack.

The corresponding analyses for the bottom of BWR- and PWR-inserts showed that both insert types have a collapse load above the specified limit load of 67.5 MPa. This analysis was done including geometrical tolerances as mentioned earlier. The results are summarised in Table 4-5. A damage tolerance analysis for the bottom showed that the maximum acceptable depth of a crack-like defect is $> 80\%$ of the material thickness.

The corresponding analysis for the steel lid is also presented in /Raiko et al. 2010/. Similarly, in this case the tolerances were chosen in such a way that the least favourable combination of manufacturing tolerances was used. The collapse load for the lid in a BWR-insert could not be calculated due to massive global collapse of the insert before reaching the collapse load for the lid. When used in a PWR-insert the collapse load for the lid was well above 100 MPa.

Summary of insert analyses

The analyses of the cast iron insert and the steel lid show that the design is very rigid to an external isostatic load of 45 MPa. Analysis of the damage tolerance of the cylindrical part of the insert shows that large defects can be tolerated without jeopardising the canister integrity. A defect size of a maximum of 20 mm can be accepted for both hole defects and crack-like defects and a 10 mm off-set of the steel tube cassette can be accepted. An off-set of 10 mm means that the edge distance, measure H in Figure 3-5, is accepted to be reduced by 10 mm.

The presented results are based on material data from inserts manufactured some years ago. As stated in /Dillström et al. 2010/ data from more recently manufactured inserts show that the performed analyses are pessimistic.

The analyses for the insert bottom and steel lid show that even when including the least favourable combination of geometrical tolerances the margin to the collapse limit load is high.

Table 4-5. Calculated collapse loads for insert bottom when using least favourable tolerances.

	Collapse load (MPa)	
	BWR	PWR
Bottom	105	100

The values of the important design parameters for the insert with regard to an isostatic load shall be:

- compression yield strength ≥ 270 MPa, the insert stands for the load elastically,
- fracture toughness $K_{Ic} > 78$ MPa(m)^½ (90% lower confidence) at 0°C to withstand brittle fracture,
- tensile yield strength of the steel lid material ≥ 335 MPa.

4.3.2 Analysis of the copper shell

The effect of the external pressure on the copper canister has been evaluated for the conditions after saturation of the buffer as well as for times of glaciations when the pressure is 45 MPa. The temperature used in calculations during glacial periods has been 27°C. At lower temperatures both the creep rate and hence the creep strain will be lower. The effects of these conditions have been simulated with FEM-modelling. The modelling is based on a copper creep model developed for the copper material used by SKB. For a comprehensive description of the model and the supporting creep testing see /Andersson-Östling and Sandström 2009/.

Results of copper shell analyses without glacial load

When the external pressure due to bentonite swelling and water pressure is applied on the canister an inward deflection of the copper lid and base will occur. The cylindrical part of the copper shell will also deflect inwards. Because of the canister design, less deflection of the cylinder occurs at the lid and the base; they are effectively acting as supports for the cylinder. This gives a slight hour-glass shape of the canister. This deformation is mainly caused by elasto-plastic deformation. Creep starts to appear after four months (10^7 s) and gets significant after three years (10^8 s). After nine years (3×10^8 s) the copper cylinder comes in contact with the insert. In Figure 4-4 the displacement of the cylindrical part of the copper shell in a radial direction is shown /Raiko et al. 2010/.

The displacement of the different elements of the cylindrical part of the copper lid and base has been modelled. The result for the lid is shown in Figure 4-5. This deformation is mainly elasto-plastic and after three years (10^8 s) some creep deformation appears. The creep deformation will mainly cause a slight rotation of the corners of the canister, caused by the geometry of lid and base. It is also in these areas where the largest creep strains are expected to appear, 12% after ten years (3.16×10^8 s). For comparison the creep strain in the cylindrical part after the same time period is well below 1% /Raiko et al. 2010/. The maximum creep strain appears at the 10 mm radii at the lid and base.

The maximum strains presented above do not take into account the slit between the contact surfaces of the copper cylinder and the copper lid or base. The vertical white line in Figure 3-8 represents the location of this slit between the copper cylinder and the copper lid. FEM-modelling taking the slits into account has been done both to estimate the maximum creep strain during glaciations and the initial plastic deformation. The initial maximum plastic deformation is about 30% in a very

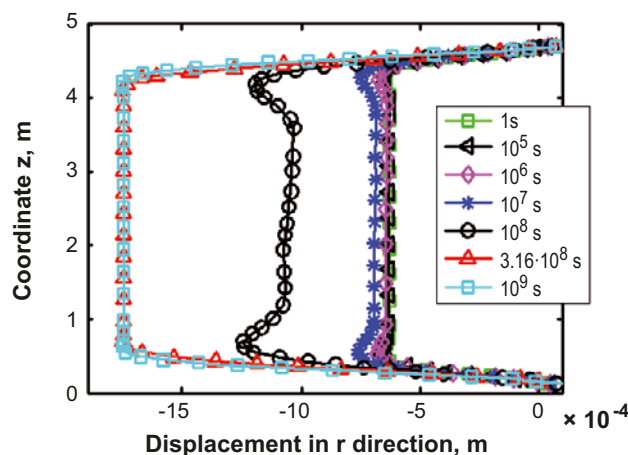

Figure 4-4. Displacement of the different elements of the cylindrical part of the copper shell in radial direction.

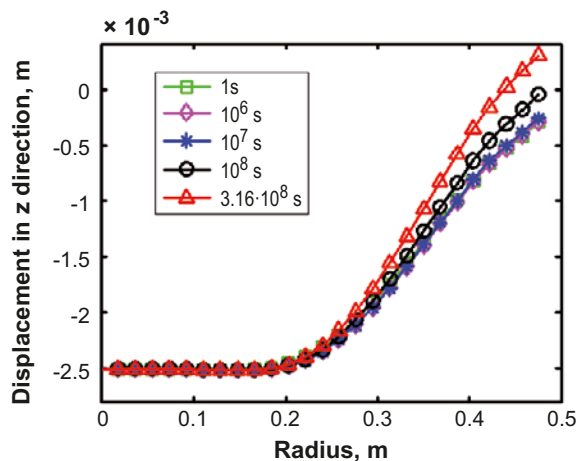

Figure 4-5. Displacement of different elements of the lid of the copper shell in axial direction.

local area /Raiko et al. 2010/. However, as seen in Figure 4-6 the effective stress and plastic strains are extremely local. The stress level drops 20% at a distance of only 0.1 mm from the position with the maximum stress when determined by the elasto-plastic modelling. Furthermore, in explaining the role of notches to creep behaviour a comparison with tensile creep testing of circumferentially notched creep specimens were made as illustrated in Figure 4-7 /Raiko et al. 2010/. These specimens were subjected to highly localised strains in tension due to the notches. The results from these tests were that a notched creep specimen can withstand higher net section stresses compared to a normal uniaxial specimen. In /Raiko et al. 2010/ no crack growth in compact tension (CT) specimens under creep deformation is reported. In addition, according to /Raiko et al. 2010/, oxygen free copper is so ductile that unstable crack growth under plastic deformation is not relevant at repository temperatures. The fracture mechanics tests made on oxygen-free copper show that the cracks in test specimen are blunted but not growing. The total conclusion is that copper is insensitive to notches both under creep- and plastic deformation.

All together this implies that the highly localised stresses and strains in the canister slits will not cause any failure and that the canister is not, from a mechanical point of view, sensitive for this type of crack-like defects.

Results of copper shell analysis with glacial load

An analysis of the effect of adding a glacial load is reported in /Hernelind 2010/ and summarised in /Raiko et al. 2010/. The analysis is pessimistic in such a way that the full pressure of 45 MPa (including glacial pressure) has been applied for a time period of 100,000 years. The conclusion from the analysis is that the maximum strain is located in the area of the slit between the copper cylinder and the copper lid. All strain is concentrated to elements at the slit, Figure 4-8. The total strain in these elements has been calculated to approximately 13% after more than 100,000 years including both the initial plastic deformation of about 11% followed by additional creep strain. The concentration of all strain to few elements in combination with the discussion about the slits earlier makes this deformation negligible. It is concluded that the lower level of strain at the slits during glacial load compared to the strain without glacial load is mainly an effect of the coarser element mesh used in the FEM for the glacial load.

Effect of indentations on the copper shell

In the manufacturing as well as during the further handling of the canisters, cold work can be introduced by accidental indentation of the copper. In /Raiko et al. 2010/ the analyses describing the effect of such indentations are summarised. The results show that even a small indentation gives quite high plastic strain in the copper that might influence the creep properties of the copper shell.

However, further experimental studies and modelling of effects from indentations and local plastic strain are required to better assess this kind of damages and, if required, develop acceptance criteria.

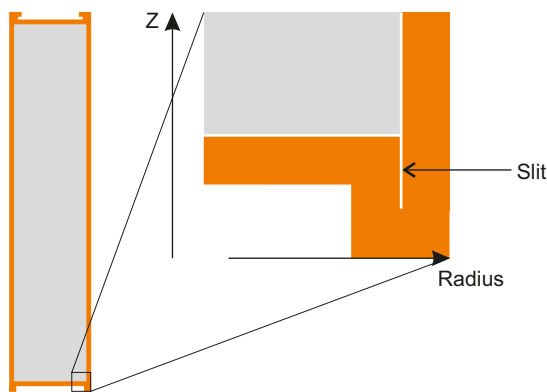
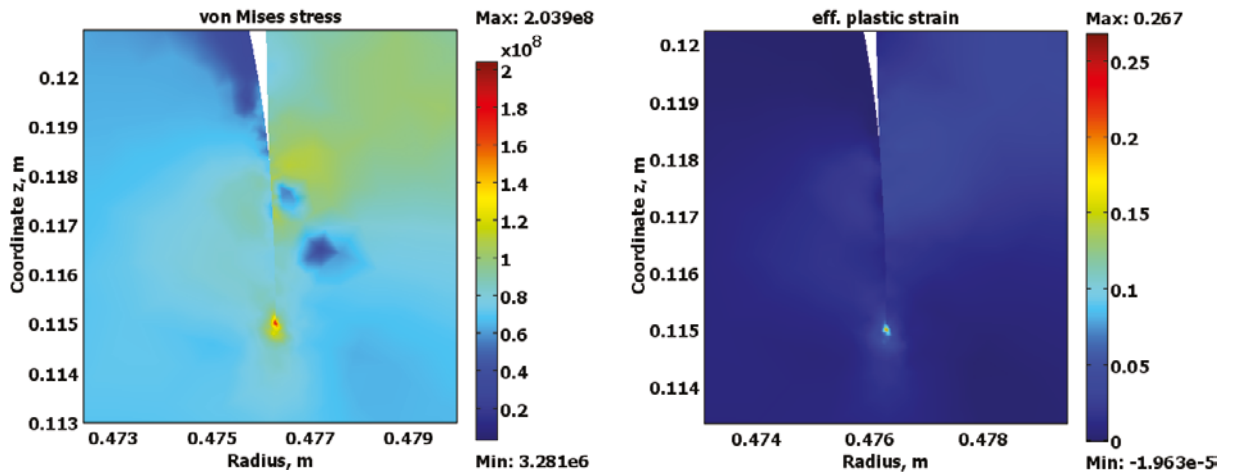

Figure 4-6. Effective stress distribution (left) and effective strain (right) in the base slit. Z is the axial direction of the canister and r the radial direction from the centre outwards.

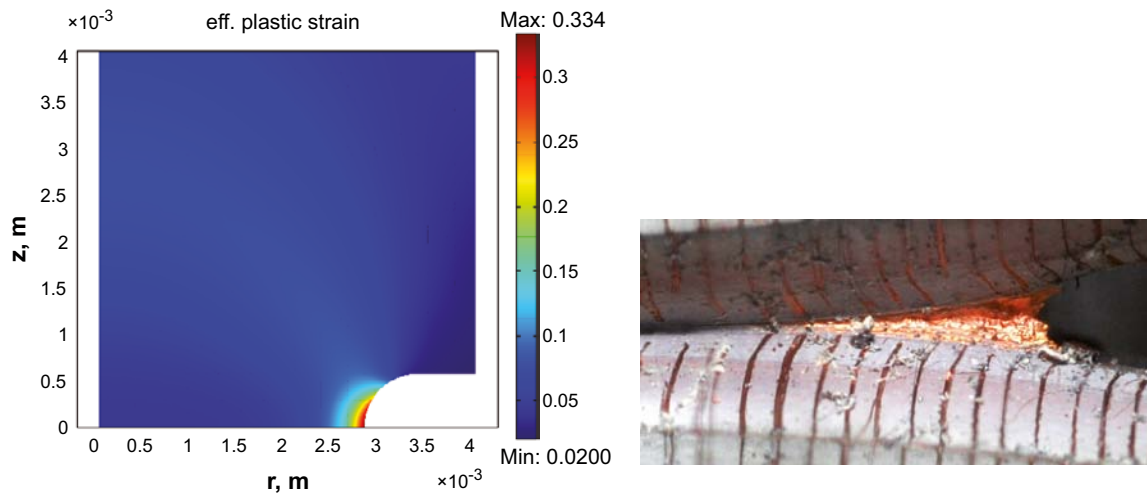

Figure 4-7. Left: effective plastic strain distribution after rigid-plastic deformation on notched specimen with notch acuity, a/R , equal to 5 and net section stress 215 MPa at 75°C (a is the radius of the specimen at the base of the notch and R is the notch root radius). Right: creep crack growth test with CT-specimen. An initial radius of 0.15 mm has been blunted to a radius of about 2 mm in 721 h at 150 MPa and 75°C. Vertical lines are a scale to measure potential crack growth.

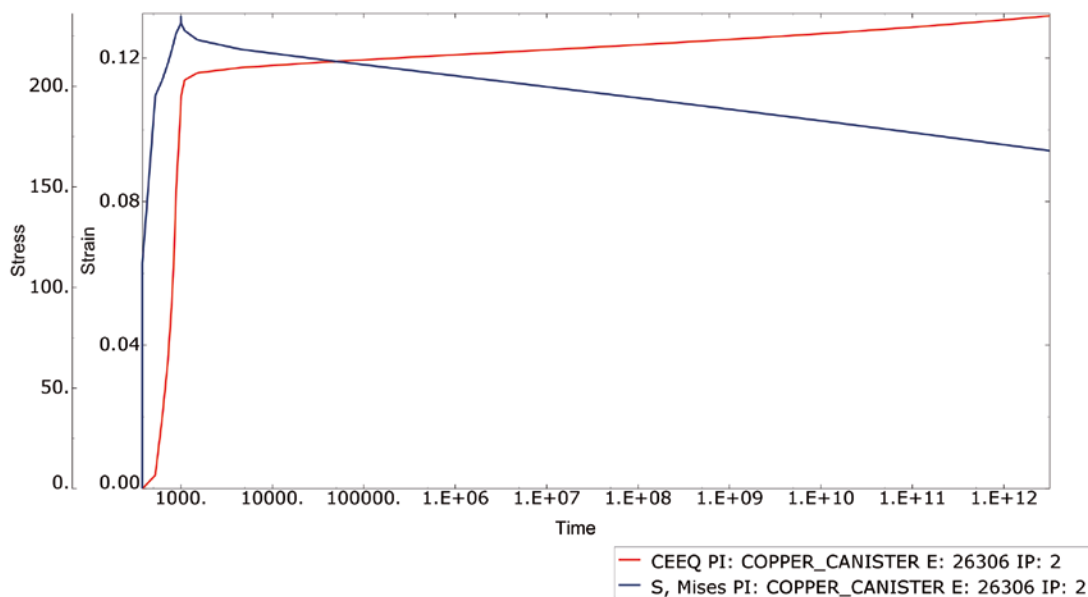
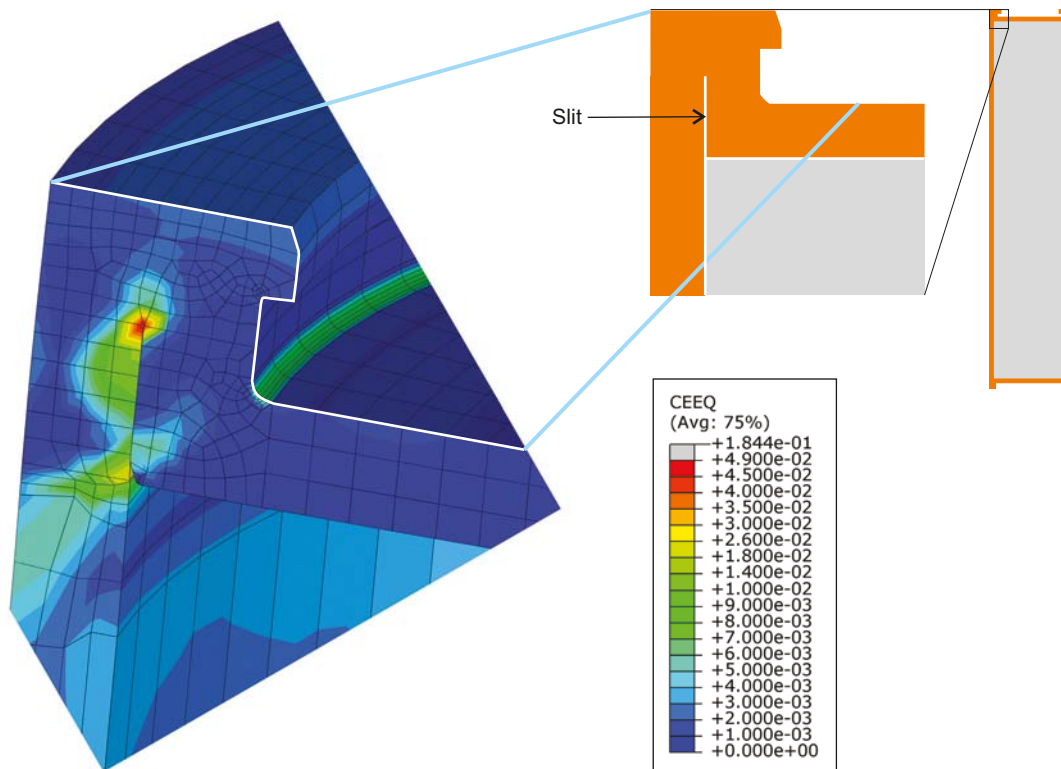

Figure 4-8. Strain concentration to elements at the slit (top figure) and Mises stress and equivalent creep strain for the exposed element (bottom figure).

Summary of analyses of the copper shell

Plastic deformation and creep deformation levels in the copper shell are generally very low, below 1%. In some parts, at the lid and base, areas can be found where the creep strain approaches 12%. In very local areas at the slits between the copper cylinder and the lid or base plastic deformations of 30% can be achieved. However, because of the very local distributions of stresses and strains at the slits creep rupture will not be initiated.

All together the results of the performed analyses show that an isostatic load case of 45 MPa external pressure will not cause any rupture if the copper shell conforms to the design parameters specified for the reference design.

The values of the important design parameters for the copper shell when subjected to an isostatic load shall be:

- creep ductility of the copper > 15% at all temperatures,
- elongation of the copper > 40% in uniaxial testing.

4.4 Shear load in the repository

Another barrier function is that the canister shall withstand shear load. The design premise in Table 2-1 specified that the copper corrosion barrier should remain intact after a 5 cm shear movement at a velocity of 1 m/s for buffer material properties of a 2,050 kg/m³ Ca-bentonite, for all locations and angles of the shearing fracture in the deposition hole, and for temperatures down to 0°C. This is derived from Section 2.3 in **Design premises long term safety** where it is also specified that the insert should maintain its pressure-bearing properties to isostatic loads.

4.4.1 Analyses of the insert

The insert has been analysed in two subsequent FEM-analyses. The analyses are summarised in /Raiko et al. 2010/. In the first analysis the canister is included in a global model where the bentonite barrier is also included /Hernelind 2010/. The bedrock is considered as very stiff during the shear movement and all deformation occurs in the buffer material and the canister. Different densities for the buffer material have been used in the global model to evaluate the effect of variations in the density. Rock shear analyses are presented in /Raiko et al. 2010/ with different directions of shearing angle in relation to the axis of the canister. The worst case for the insert is presented, as when shearing is perpendicular to the axis of the canister at $\frac{3}{4}$ of the height from the bottom. All results presented in this report are valid for BWR-inserts only. In /Raiko et al. 2010/ the PWR-insert shows lower magnitudes of maximum stresses and strains compared to a BWR-insert. However, since the development of the PWR-insert is still ongoing, and as stated in /Raiko et al. 2010/ the material properties for PWR-inserts remain to be verified, data based on BWR-inserts have been used for all analyses. As the shear load case has a dynamic nature strain-rate dependent data has been used for both the bentonite and insert material. The data used for representation of the stress-strain relation for the insert material in shear load case is given in Table 4-6.

The global model, as mentioned above, cannot be used for damage tolerance analysis. Instead a sub model, Figure 4-9, with smaller elements is used for this purpose. The sub-model is inserted into a new global model adapted for the damage tolerance analysis. This model only comprises the canister. Defects are introduced directly in the sub-model and the displacements from the first global model analysis are applied on the boundary of the new model.

The defects introduced in the sub-model have been semi-elliptical or semi-circular surface cracks or elliptical or circular internal cracks. The geometry of a semi-elliptical surface crack is shown in Figure 4-3. The sub model conditions are applied where the highest principal tensile stresses were identified to occur in the global model, Figure 4-10. The size of the sub-model is adjusted depending on the location and size of the postulated defect, details are given in /Dillström and Bolinder 2010/. In the damage tolerance analysis, the J -integral is calculated along the crack front of the postulated defect. This value is then used together with J_{mat} that is the fracture toughness value that has been determined experimentally for the ductile cast iron in the insert.

In /Raiko et al. 2010/ it is stated that the results so far shows that a rock shear movement occurring when the glacial pressure is not present is a more severe scenario for the insert compared to a rock shear occurring when a glacial load is present. This is mainly due to the fact that the maximum tensile stress in the axial direction of the canister, that is detrimental for crack growth, decreases when a glacial load is added. The damage tolerance analysis results are therefore calculated without glacial load.

Table 4-6. Values used in strain rate dependent shear case at 0°C and strain rate.

Property	Values used in strain rate dependent shear case at 0°C and strain rate=0*
Yield strength in tension (MPa)	True stress (MPa) / plastic strain (%)
	293/0
	324/1
	349/2
	370/3
	389/4
	404/5
	418/6
	428/7
	438/8
	447/9
	456/10
	465/11
	472/12
	478/13
	484/14
488/15	
491/16	

* The strain rate factor was defined according the testing and a constant value of 1.08 was used at strain rate 0.5/s and the values between static and the 0.5/s were interpolated using the actual strain rate /Hernelind 2010/.

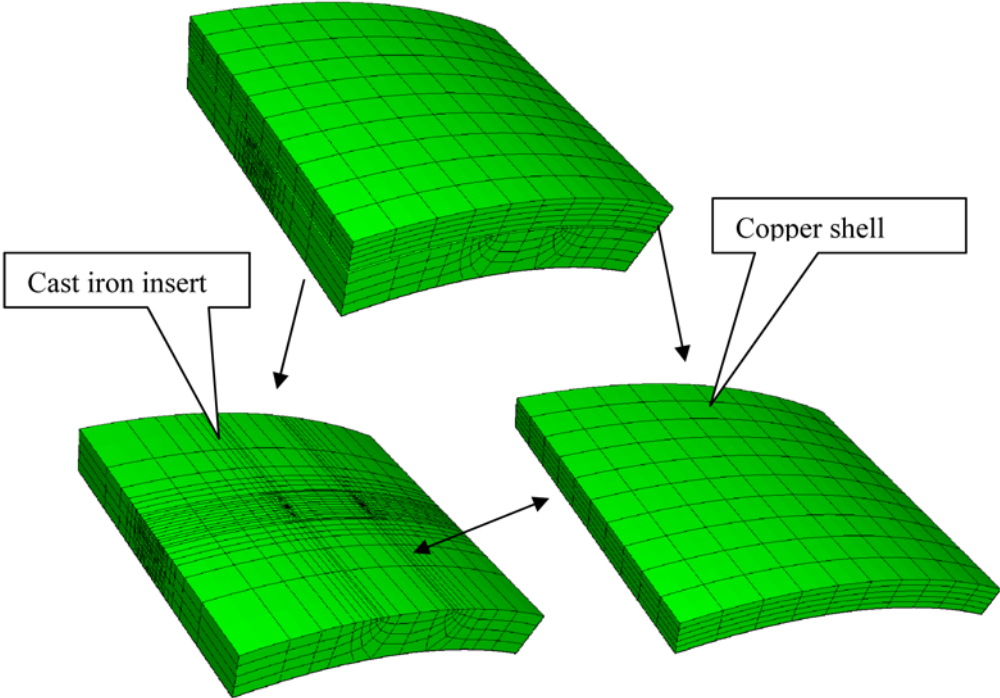

Figure 4-9. Sub model, here for a semi-elliptical surface crack, this is inserted to the global model in Figure 4-10.

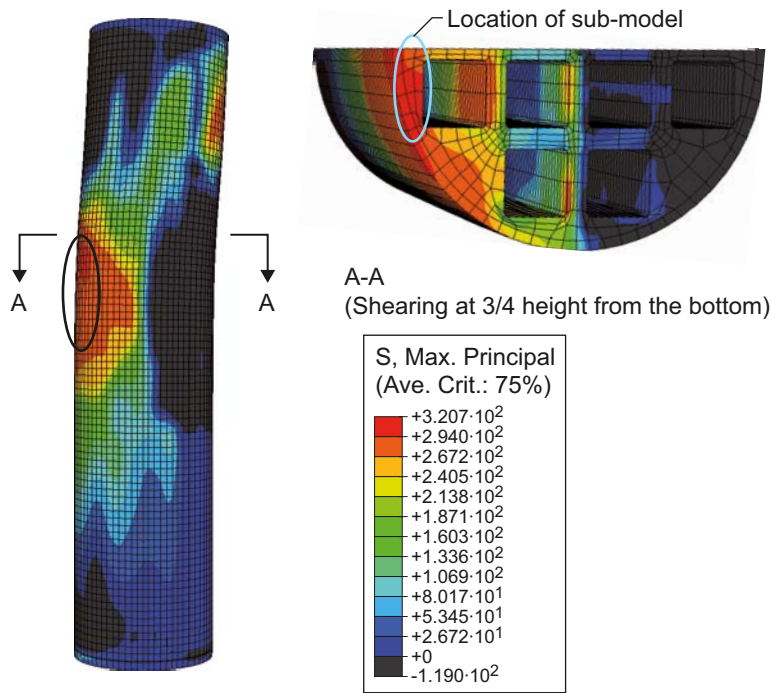

Figure 4-10. Identification of location for sub model.

Safety factors

The critical defect size in the damage tolerance analysis is given using the criteria $J = J_{mat}$ and consequently the acceptable defect size is given by using the criteria $J = J_{mat}/SF_J$ where J is the calculated fracture toughness, J_{mat} is the fracture toughness of the cast iron used in the insert and SF_J is the applied safety factor. According to the discussion in /Dillström and Bolinder 2010/ it is reasonable to use the fracture toughness value at 2 mm stable crack growth. This gives that $J_{mat} = J_{2mm} = 88 \text{ kN/m}$ (lower 90% confidence interval) /Dillström and Bolinder 2010/. The use of confidence intervals is a conventionally used way when doing a statistical approach for interpretation of data for material properties, see also /Raiko et al. 2010/.

The safety factor $SF_J = 2$ is used for the present shear load scenario, based on ASME Sect XI and the fact that this is a load case with low probability of occurrence as stated in Section 2.3 of **Design premises long term safety**.

Results of damage tolerance analysis of the insert

The damage tolerance analysis reveals that the most severe defect geometry is a semi-elliptical surface crack. This kind of defect generates the highest J -value at the crack front, also when compared to a defect inserted in areas with large strains. The acceptable defect sizes for the defects introduced to areas with maximum principal stress are summarised in Table 4-6. As seen in Table 4-7 the acceptable defect size is very dependent on the density of the buffer. The highest density, 2,050 kg/m³ gives the worst case.

The models used are named *model6g_normal_quarter_xxxxca3* means that the rock shear is perpendicular (*normal*) to the axis of the canister at $\frac{3}{4}$ height from the bottom, *ca3* that the bentonite used is Na-bentonite converted to Ca-bentonite and *xxxx* is the density of the bentonite.

Summary of rock shear analyses for the insert

The rock shear load has been analysed using strain-rate dependent material data for the bentonite and the insert material. A worst case scenario regarding the density of the bentonite gives that the canister can withstand a 5 cm rock shear if the maximum defect size is according to Table 4-7. However, the influence of the bentonite density is strong and a lower density is beneficial for the canister during

Table 4-7. Acceptable defect sizes for postulated defects (shear load case, 5 cm shearing).

Postulated defect geometry	Model	Acceptable depth [mm]	Acceptable length [mm]
internal elliptical defects	model6g_normal_quarter_2050ca3	>10	>60
internal circular defects	model6g_normal_quarter_2050ca3	>10	>10
semi-elliptical surface cracks	model6g_normal_quarter_2050ca3	4.5	27.0
	model6g_normal_quarter_2000ca3	8.7	52.2
	model6g_normal_quarter_1950ca3	>10	>60
semi-circular surface cracks	model6g_normal_quarter_2050ca3	8.2	16.4

a rock shear. A design parameter extracted from the analyses is that the fracture toughness for the nodular cast iron must fulfil $J_{2mm} \geq 88$ kN/m (lower 90% confidence interval).

No sensitivity analysis of the influence of scatter in material data, e.g. yield strength, has been done /Raiko et al. 2010/.

4.4.2 Analysis of the copper shell

The strain and stress levels in the copper shell have been evaluated using the global model mentioned above /Hernelind 2010/. Evaluations have been done including short-term analyses to find the plastic strains that the copper is exposed to during the shear movement. Complementary analyses including assessments of the creep in the copper shell after the shear movement have also been done to determine the levels of creep strains that can be expected after a rock shear (long-term shear analyses). The creep analyses have been done by incorporating the copper creep model /Raiko et al. 2010, Andersson-Östling and Sandström 2009/ into the global model.

Results of copper shell analysis

The short-term analyses showed that, for the case of rock shear perpendicular to the axis of the canister, the maximum plastic strain in the copper shell can exceed 20%. However, this value is only reached in areas where the geometry is discontinuous /Raiko et al. 2010/. Besides these regions the highest strain values occurs at top fillets. The strain is here below 10% even for 10 cm rock shear amplitude /Hernelind 2010/. This is the same order of magnitude as for the creep strain in the long-term analyses where creep is included /Hernelind 2010/. This means that most of the copper strain is caused by the immediate plasticity during the rapid rock shear load case and the creep after the rock shear will only relax the stresses in the bentonite-copper-iron construction. In general, the highest strains are localised to radii in the lid or base, see Figure 4-11.

4.5 Uneven swelling pressure from bentonite buffer

The canister may be subjected to asymmetric loads during different phases in the repository evolution. This could temporarily occur due to uneven water saturation in the buffer. Permanent asymmetric loads may occur due to uneven density distribution of the saturated buffer due to irregularities in the geometry of the deposition holes.

4.5.1 Analyses of uneven swelling pressure

The evaluation of the maximum bending stresses in the canister during these phases has been evaluated with simplified calculations that are summarised in /Raiko et al. 2010/. The result is that the maximum bending stress during the water saturation may be $\sigma_b=105$ MPa. After full water saturation, the corresponding value is 111.5 MPa. This is a pessimistic assumption that is only reached in the case when a curved deposition hole and local rock fall out happens to coincide. In Section 2.2 of **Design premises long-term safety** it states that pessimistic assessment of asymmetric loads have too low probability to be considered to coincident with the shear load. This combination has therefore not been analysed.

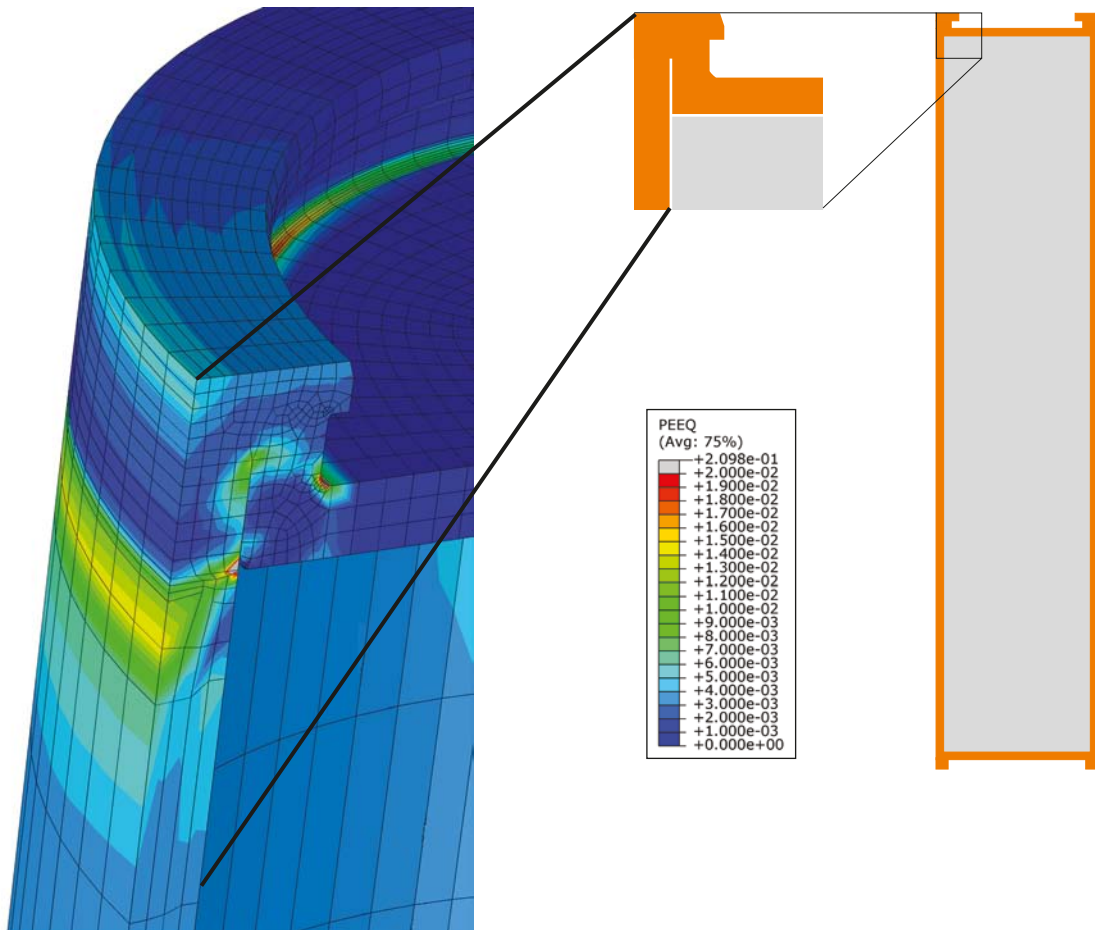

Figure 4-11. Plastic strain at the copper shell top lid. Note the local area of high strain that is present at geometrical discontinuity.

In /Raiko et al. 2010/ it is also stated that for tensile stresses this load case is worse during periods without glacial pressure since the glacial pressure tends to lower the tensile stresses in the insert that are causing cracks to grow. The consequence of the bending stresses for the insert is handled in a damage tolerance analysis. In the analysis, the maximum acceptable defect size is calculated in similar way as for the isostatic load case in Section 4.3. However, for the bending stresses the worst crack-like defect is located on the surface of the insert in radial-tangential direction where the highest principal stresses are identified. The shape of the postulated crack is semi-elliptical according to Figure 4-3.

Safety factors

Since this load case when resulting in the calculated maximum bending stresses is a completely unlikely case it is possible to use lower safety factors according to ASME rules. For K_{Ic} 1.41 was used instead of 3.16 as mentioned for the analysis of the insert during an isostatic load, Section 4.3.

Results of analysis

The result of the damage tolerance analysis presented in /Raiko et al. 2010/ gives that the maximum acceptable depth of the crack is $a=48$ mm where a is according to Figure 4-3. This load case gives no new design parameters for the canister.

4.6 Corrosion load

One of the barrier functions of the canister is to provide a corrosion barrier. The design premise in Table 2-1 specified that the required nominal thickness of the copper shell is 5 cm. This is derived from Section 2.4 in **Design premises long term safety**.

The nominal copper shell thicknesses with acceptable tolerances for the reference canister are:

- copper tube: 49 ± 0.3 mm,
- welds: 48.5 ± 0.7 mm,
- lid: 50 ± 0.6 mm,
- base: 50 ± 1.0 mm.

4.7 Prevention of criticality

The spent fuel properties and geometrical arrangement in the canister should be such that criticality is avoided even if water should enter a canister.

In the analysis of the propensity for criticality of fuel assemblies placed in the canister, the sensitivity of the canister material composition and dimensions are investigated, see Section 4.4.1 in **Spent fuel report**. The analyses are based on an insert made of nodular cast iron with an iron content of at least 90%. To prevent criticality elements that absorb neutrons are favourable. Of the elements occurring in nodular cast iron silicon (Si) and carbon (C) are less favourable from this point of view than iron (Fe). The content of these elements shall therefore be kept below 6% (C) and 4% (Si). The important dimension of the canister insert is the distance between the channel tubes, which shall conform to the reference design.

4.8 Additional design premises derived from the safety assessment

In addition to the design premises related to required barrier functions and loads in the repository, there are several additional design premises on the canister that have been derived from the safety assessment. These are given as specifications or similar in Section 3.1.5 of **Design Premises long term safety** and are listed in Section 2.3.1 of this report.

- The copper content in cast iron shall be $< 0.05\%$ to avoid that gamma radiation induce hardness and embrittlement in cast iron.
- The copper material is a highly pure copper to avoid corrosion at grain boundaries. Oxygen contents of up to some tens of ppm can, be accepted. However the material used in trial production has had the specification $O < 5$ ppm. The creep ductility of the copper material is upheld if; phosphorus 30–100 ppm, sulphur < 12 ppm, average grain size $< 800 \mu\text{m}$, and embrittlement is avoided if the hydrogen content is < 0.6 ppm. These figures assume that the content of other elements are also limited.

These design premises are all considered in the specification of the reference canister, see Chapter 3, and will not be further discussed here. The measures taken in the production to verify that the produced canisters conform to these specifications are described in Chapter 5.

Further, it is stated that corrosion due to formation of nitric acid can be neglected if the radiation dose rate is less than 1 Gray/h. The radiation dose rate at the canister surface will depend both on the radiation shielding provided by the canister and the radioactivity of the encapsulated spent nuclear fuel. The design premise is verified for the reference design of the canister and the fuel assemblies selected for encapsulation, see the **Spent fuel report**, Sections 4.4.1 and 4.7.2.

4.9 Design premises from the spent nuclear fuel

The canister shall contain the various types of spent nuclear fuel that are included in the currently approved Swedish nuclear power program. The largest cross sections for BWR and PWR assemblies set the design premises for the interior channel tube cross sections in the inserts.

In the canister reference design the internal channel tube cross section is valid before casting. During casting this dimension change and the acceptable dimensions after casting are given by a gauge. Dimensions connected to internal channel tube cross sections are given in Table 4-8.

The measures taken in the production to verify that the produced canisters conform to these specifications are described in Chapter 5.

With respect to the required control of fissionable material, the canister shall be marked with a unique identity that must remain visible after sealing and inspection of the canister, and be readable when the canister is placed in the deposition hole. The documentation of the spent fuel assemblies placed in each canister is described in the **Spent fuel report**, Section 4.7. Each canister is marked on the lid as described in Section 5.1.3.

4.10 Design premises related to production and operation

4.10.1 Mechanical loads during handling in the facilities

From the time the copper lid has been welded in place until the final disposal, the canister will be handled a few times by lifting by the copper lid. The handling must be done in a safe way in order not to drop the canister as well as not to interfere with the barrier functions of the copper shell.

Analysis of handling loads

FEM analyses have been done for the copper canister both with and without postulated defects /SKBdoc 1206868, Raiko et al. 2010/. Three different types of defects were used, see also Figure 4-12.

Defect 1: Fully circumferential internal defect with 18 mm extent in radial direction in the copper shell.

Defect 2: Fully circumferential surface defect with 30 mm extent in radial direction in the copper lid.

Defect 3: Fully circumferential internal defect with 40 mm extent in radial direction in the copper lid.

The worst case that can be defined from /SKBdoc 1191524/ is when the canister is being lowered with maximum speed, 33 mm/s and a sudden stop occurs. This is load case 1. For comparison a load case, where the canister is falling free from a height of approximately 7 meters when a sudden stop occurs, has been included in the analysis, load case 2. This case is merely theoretical but it gives an idea about the strength of the canister in relation to the loads during handling. The acceptance criterion for the analysis is that the applied load must not be beyond 2/3 of the collapse load, based on the ASME code.

Table 4-8. Dimensions connected to internal channel tube cross sections.

	BWR	PWR
Design premises	145.5 × 145.5 mm	228 × 228 mm
Largest cross section of fuel assembly Table 2-2		
Reference design	160 × 160 mm	235 × 235 mm
Int. channel tube cross section before casting (Table 3-4 and 3-5)		
Gauge dimensions (used after casting)	152 × 152 mm	226 × 226 mm*

* Development of PWR insert is in progress.

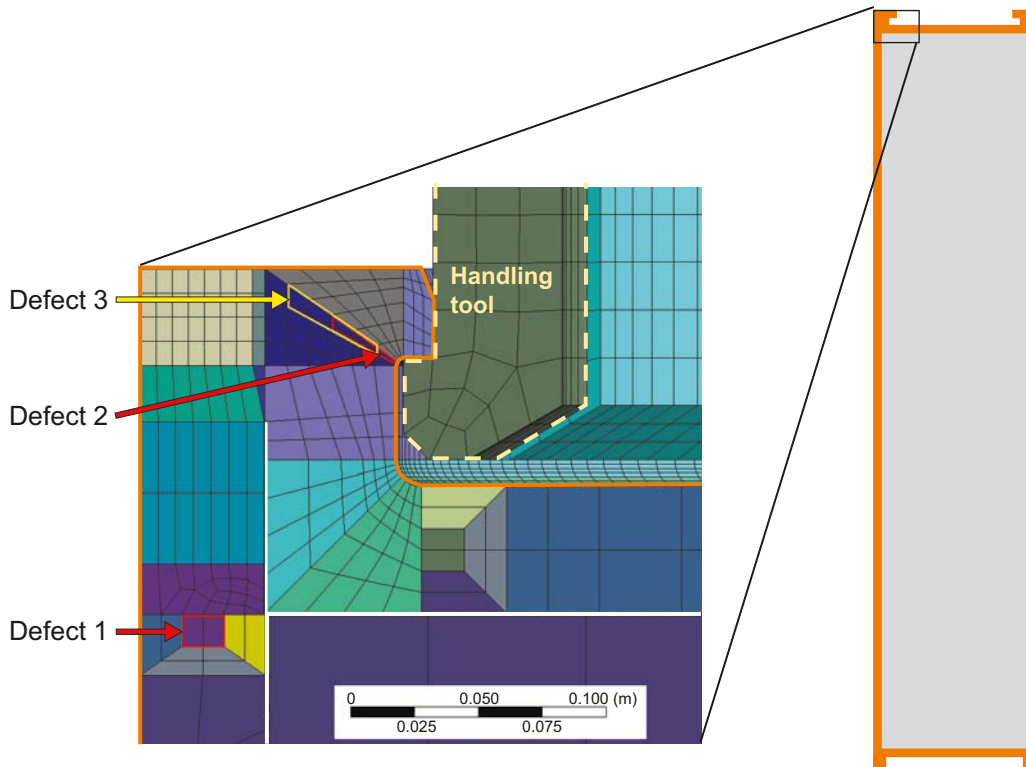

Figure 4-12. Removed volumes to model large defects.

Results of the handling load analysis

Both load cases show large margin to the collapse load even when defects are included in the analysis /Raiko et al. 2010/. The results are summarised in Table 4-9. It can be seen that no combination of loads and defects come even close to the maximum accepted load.

4.10.2 Average grain size of the copper

A preliminary acceptance criterion on the average grain size in copper is set to $< 360 \mu\text{m}$ based on that ultrasonic testing has been chosen as the main inspection technique. As the requirement for acceptable defects will be developed, the level for acceptable average grain size might need to be changed to facilitate the ultrasonic inspection.

Table 4-9. Results for limit load analysis for copper shell with and without defects.

	Copper shell without defect		Copper shell with defect 1	
	Load case 1	Load case 2	Load case 1	Load case 2
$2/3 \cdot F_{\text{collapse}}$ (kN)	3,333	3,333	3,333	3,333
F (kN)	273	922	273	922
Margin $F / (2/3 \cdot F_{\text{collapse}})$	0.08	0.28	0.08	0.28
	Copper shell with defect 2		Copper shell with defect 3	
	Load case 1	Load case 2	Load case 1	Load case 2
$2/3 \cdot F_{\text{collapse}}$ (kN)	1,473	1,473	3,193	3,193
F (kN)	273	922	273	922
Margin $F / (2/3 \cdot F_{\text{collapse}})$	0.19	0.63	0.09	0.29

4.11 Summary of results and conclusions

In this section, the results of the verifying analyses are summarised and the conformity of the reference design to the design premises related to the barrier functions is concluded.

4.11.1 Isostatic load in the repository

A barrier function of the canister is to withstand mechanical loads. It shall thus withstand the largest expected isostatic load in the repository. This load depends on the groundwater pressure and on the swelling pressure of the buffer. As stated in the Section 2.2 of **Design premises long-term safety** severe loss of structural integrity such that the canister's containment function can no longer be claimed can be used as the criterion for canister failure. The design premise is that: the canister shall withstand an isostatic load of 45 MPa, being the sum of maximum swelling pressure and maximum ground water pressure.

The major contribution to the mechanical strength of the canister is provided by the insert although the copper shell also contributes to the strength. The canister properties that are important for the isostatic load case are the design parameters and the acceptable defect size calculated in the damage tolerance analysis (see Section 4.3). The required properties expressed as design parameters are given in Table 4-10:

- material properties in the insert – compression yield strength and fracture toughness,
- dimensions of the insert – edge distance,
- mechanical properties in the steel lid – tensile yield strength,
- material properties copper shell – elongation and creep ductility.

Acceptable sizes of crack like defects according to ASME and postulated volumetric defects (holes) have been investigated. The acceptable sizes are dependent on their location in the insert. Typical values valid for the outer part of the insert are crack depths of 32 mm and hole diameters of 20 mm. For the bottom part of the insert, axial crack-like defects with a depth of up to 80% of the material thickness can be accepted.

In Section 4.3.1, it is verified that the canister strength is sufficient to withstand an isostatic load of 45 MPa provided that it conforms to the design parameters specified in Table 4-10. The calculations show that the canister will withstand the isostatic load and that the insert is resistant against rather large defects. In addition, the probabilistic analysis of the insert shows a probability below 1×10^{-50} for failure.

Cold work (plastic) strains might influence the creep properties of the copper shell. However, minor indentations (local cold work) to the surface are not judged to jeopardise the integrity of the copper shell at the creep strains expected under repository conditions /Raiko et al. 2010/. Further experimental studies and modelling of effects from indentations and local plastic strain are required to better assess this kind of damage and, if required, develop acceptance criteria to ensure that the creep properties of the copper shell is maintained during the whole canister production line.

Table 4-10. Design parameters of importance for the isostatic load case.

Canister component	Design parameter	Reference value
Insert	Compression yield strength	> 270 MPa
	Fracture toughness, K_{Ic}	78 MPa \sqrt{m} (lower 90% confidence)
	Edge distance (BWR-insert)	33.3 \pm 10 mm
Copper shell	Elongation	> 40%
	Creep ductility	> 15%
Steel lid	Tensile yield strength	> 335 MPa

4.11.2 Shear load in the repository

To maintain the barrier function to withstand mechanical loads, in addition to the maximum isostatic load, the canister shall withstand shear load. In design premises related to the barrier functions it is specified that this means that the copper corrosion barrier should remain intact after a 5 cm shear movement at 1 m/s for buffer material properties of a 2,050 kg/m³ Ca-bentonite, for all locations and angles of the shearing fracture in the deposition hole, and for temperatures down to 0°C. The insert should maintain its pressure-bearing properties to isostatic loads.

The major contribution to the mechanical strength of the canister is provided by the insert although the copper shell also contributes to the strength. The canister properties important for the shear load case are the design parameters and the accepted defect size calculated in the damage tolerance analysis (see Section 4.4).

The required properties expressed as design parameters are given in Table 4-11:

- material properties in the insert – tensile yield strength and fracture toughness,
- material properties copper shell – elongation and creep ductility.

The damage tolerance analyses show that the insert withstands the shear load case. The maximum accepted depths of crack-like surface defects with a semi-elliptical shape is 4.5 mm and 8.2 mm for a semi-circular shape. The insert is less sensitive to internal defects, allowing elliptical defects of > 10 mm and circular defects > 10 mm. The analyses also show that the results are clearly dependent on the buffer density. A lower buffer density means that larger defects can be accepted in the insert.

In Section 4.4, it is verified that the canister strength is sufficient to withstand the shear loads provided that it conforms to the design parameters specified in Table 4-11. The calculations show that the canister will withstand the shear load but that only small defects can be accepted. These results are based on pessimistic assumptions, mainly on the material properties of the bentonite, and therefore the acceptable size of defects most probably increases if more realistic data are used in the calculations.

4.11.3 Uneven pressure from bentonite buffer

The canister may be subjected to asymmetric loads during different phases in the repository evolution. This could temporarily occur due to uneven water saturation in the buffer. Permanent asymmetric loads may occur due to uneven density distribution of the saturated buffer due to irregularities in the geometry of the deposition holes. The resulting bending stresses in the cast iron insert are in all considered cases lower than the yield strength.

The canister properties and design parameters that are important for loads from uneven pressure from the bentonite buffer are in principle the same as for the isostatic load case. One additional requirement, however, is based on circumferential crack-like defects in the insert. The acceptance level is not too demanding since defects with up to 48 mm depth can be accepted. Such defects are not at all expected to occur in the manufacturing process.

The calculations presented in Section 4.5 verify that the canister strength is sufficient to withstand the uneven pressure from the bentonite buffer provided that it conforms to the design parameters specified in Table 4-10.

Table 4-11. Design parameters of importance for the shear load case.

Canister component	Design parameter	Reference value
Insert	Tensile yield strength	267 MPa
	Fracture toughness, J_{2mm}	> 88 kN/m (lower 90% confidence)
Copper shell	Elongation	> 40%
	Creep ductility	> 15%

4.11.4 Corrosion load

One of the barrier functions of the canister is to provide a corrosion barrier. The copper in the canister is of high purity (> 99.99% Cu) and an oxygen content of up to some tens of ppm is accepted. The related canister properties and design parameters determined in the design (see Sections 3.1 and 3.2) are:

- copper shell dimension – thickness including defects,
- copper shell material composition – oxygen content.

The nominal copper shell thicknesses with acceptable tolerance for the reference canister are:

- copper tube: 49 ± 0.3 mm,
- welds: 48.5 ± 0.7 mm,
- lid: 50 ± 0.6 mm,
- base: 50 ± 1.0 mm.

The reference canister conforms to the specified oxygen content in the copper shell. The conformity of the copper shell thickness in the reference canister to the design premises is further discussed in Sections 7.1.1 and 7.1.5.

4.11.5 Prevention of criticality

The canister shall prevent criticality and in the analysis of the propensity for criticality of the encapsulated spent fuel assemblies, it was shown that from a reactivity standpoint the worst case is when the assemblies are located close together towards the centre of the canister. With respect to this, it must not be possible to place the fuel assemblies closer to each other than the minimum distance between the channel tubes specified for the reference design. To prevent criticality elements that absorb neutrons are favourable. Of the elements occurring in nodular cast iron silicon (Si) and carbon (C) are less favourable from this point of view than iron (Fe). The content of these elements shall therefore be kept below 6% (C) and 4% (Si).

4.11.6 Additional design premises derived from the safety assessment

In addition to the design premises related to the required barrier functions discussed in previous sections there are several additional design premises derived from the safety assessment. The reference canister conforms to the following specifications:

- composition in insert: copper content in cast iron < 0.05%,
- composition in copper shell: phosphorus 30–100 ppm, sulphur < 12 ppm, hydrogen content < 0.6 ppm, oxygen up to some tens of ppm and average grain size < 800 μm .

5 Manufacturing of canisters

This chapter describes the manufacturing of canisters and includes activities in conventional industrial plants in which the canister components are manufactured and assembled, see Figure 5-1. The encapsulation of the fuel, transportation, handling and deposition of the canister are presented in Chapter 6.

5.1 Overview

The purpose of the chapter is to describe the production system for canisters and to verify that it delivers canisters that conform to the specifications for the reference canister. The chapter describes all stages in the manufacturing of the canisters and the inspections to be performed. The inspection work includes self-inspections, which are conducted at different stages of the manufacturing in order to guarantee a reliable product. It also includes final inspections that are carried out to verify the conformity to the reference design. The descriptions and data given in this chapter for the canister production are based on the technical development completed by the middle of 2008. The presented production and inspection methods will be further developed and optimised before the construction of the KBS-3 repository commences.

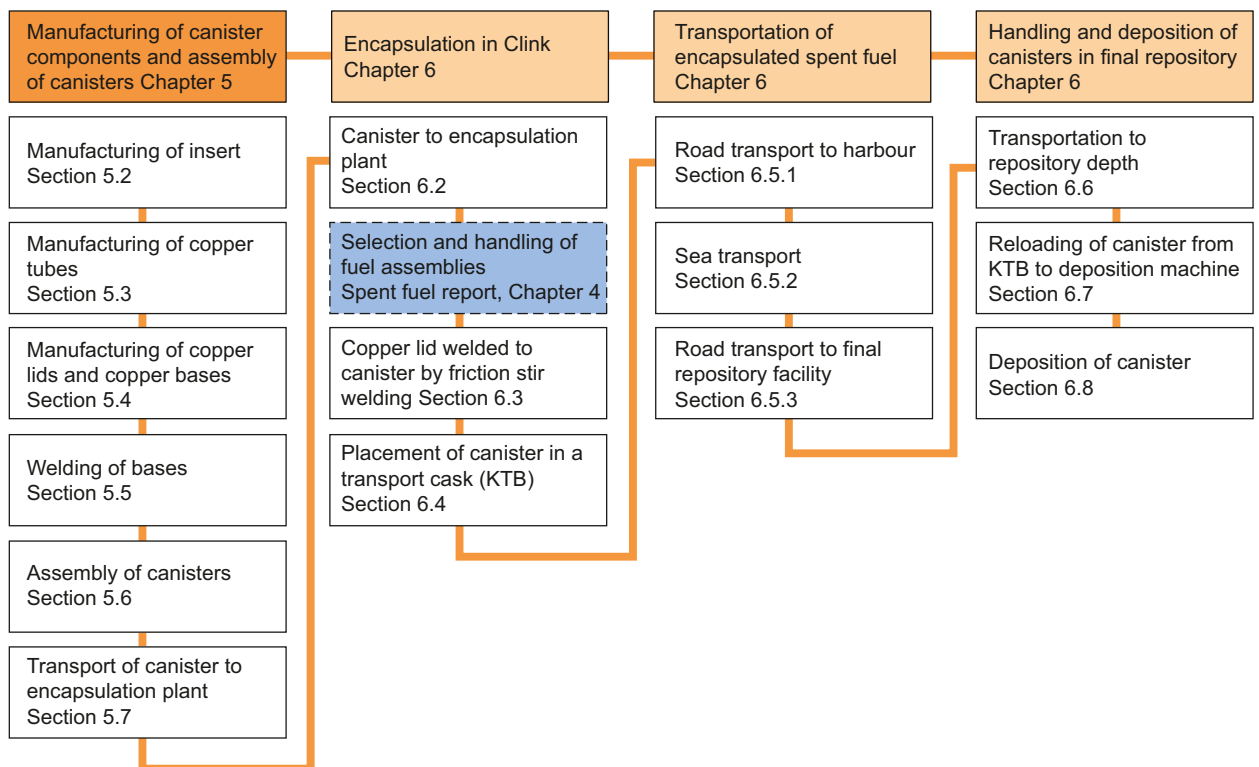

Figure 5-1. The main parts of the canister production line (orange) and flow chart for all stages, including references to the sections in the text where they are described. The main part presented in this chapter is highlighted.

5.1.1 Reference methods for manufacturing of canisters

The production system for the manufacturing of canisters comprises a network of suppliers who manufacture the canister components and a canister factory that is to be run by SKB where the final machining, final inspections and assembly of the components into canisters will be carried out. Manufacturing methods described in this report are:

- casting of insert in nodular cast iron,
- casting of copper ingot,
- extrusion of copper tube,
- forging of copper lid and base,
- welding by means of friction stir welding (FSW).

5.1.2 Strategy for inspections

In order to guarantee the canister properties, a number of different inspections are needed which are to be carried out in accordance with established standards and also on the basis of procedures developed by SKB. Inspections consist of non-destructive testing (NDT), destructive testing, material analysis and dimension inspections.

If the ingots and components that are manufactured on the suppliers' premises, i.e. inserts, copper tubes, and lids/bases, do not conform to the stipulated acceptance criteria SKB will not accept delivery to the canister factory. Components with unacceptable deviations that are discovered in the final inspections at the canister factory will also be rejected.

A final inspection will also be carried out in the final repository to verify that sensitive areas of the canister not have been subjected to deformations and indentations.

5.1.3 Requirements for the manufacturing of canisters

Manufactured canisters shall conform to the specifications presented for the canister reference design in Chapter 3. In addition, the design considerations presented in Section 2.2.2 shall be regarded as follows.

- Methods and systems of manufacturing, welding and inspecting the canisters shall be based on tested or well-proven techniques.
- The degree of reliability and reproducibility of systems and processes shall be sufficiently high to guarantee safety during operation and after deposition.
- The production system shall meet the demands on the final repository system for capacity and sustainability over a prolonged period of time.

According to Sweden's commitment regarding non-proliferation and planned actions to control the management of fissionable material within the KBS-3 system, the canister is a report unit and shall have a unique identity. The identity must be clearly visible after sealing and machining of the canister, and readable when the canister has been placed in the deposition hole. Each canister is given a unique identity number. The identity is milled in with a character height of 30 mm, a milling width of 2 mm and a depth of 1 mm in the centre of the top surface of the lid.

5.1.4 Design parameters and production-inspection schemes

A description of the canister reference design in terms of design parameters is given in Chapter 3. The design parameters are strongly linked to properties that the canister shall have in order to conform to the design premises. During the course of production, the design parameters are determined and, directly or indirectly, inspected to verify the conformity to the reference design.

Certain specifications given to suppliers of canister components may be more stringently formulated than for the reference design. This is done in order to secure that the manufacturing will result in components within the acceptable tolerances given for the reference design. These specifications are hereinafter referred to as technical specifications.

To give an overview of the production and how design parameters are processed and inspected *production-inspection schemes* illustrating the production stages are presented in Section 5.2.1 for the insert, 5.3.1 for the copper tube, 5.4.1 for the copper lids and bases and 5.5.1 for the welds.

In the production-inspection schemes stages where the design parameters are processed are marked with blue colour. Light blue is used for any processing of design parameters and darker blue is used for processes that finally determine one or several design parameters. Determining a parameter means that the parameter is determined within the stage and that no active efforts are, or can be, made to alter it in the following stages of the production.

For the tests and inspections orange colour is used. Lighter colour is used for any inspections of the design parameters during the production and darker orange is used for final test and inspections. After final inspection no further inspections are possible to perform.

5.2 Manufacturing of insert

The insert is the pressure-bearing component in the canister and shall conform to the specified strength design parameters. The inserts are manufactured from nodular cast iron. This material belongs to the cast iron group, which has been in use since 1948 and has attracted increasing use in advanced structures. The form of the graphite in the nodular cast iron has a major impact on the qualities of the material; this is controlled through the addition of small quantities of certain substances to the molten metal.

The strength properties, the fact that nodular cast iron has good casting properties and that it is relatively easy to machine, are some of the reasons why nodular cast iron was chosen to be the material used for the inserts. The trial manufacturing of inserts has been performed at a number of foundries.

Casting, machining and parts of the quality control, such as material analysis and destructive testing of inserts, will be carried out by suppliers, whereas the machining to final dimensions and quality control such as non-destructive testing and dimension inspection will be carried out by SKB in the canister factory.

A detailed description of the development status for the insert is provided in the Manufacturing Report /SKBdoc 1175208/.

5.2.1 Production inspection scheme for the manufacturing of the insert

To give an overview of the production and how the design parameters are processed and inspected, production-inspection schemes for the different production stages are provided see Section 5.1.4. The production-inspection schemes for the manufacturing of the steel lid and insert are shown in Figure 5-2 and Figure 5-3 respectively.

Property	Design parameter	Manufacturing of steel lid
Material composition	Structural steel in lid	Manufacturing of steel lid
		Material certificate from supplier
Material properties	Yield strength Ultimate tensile strength	Manufacturing of steel lid
		Material certificate from supplier
Dimensions	Lid diameter Lid thickness Bevel angle	Manufacturing of steel lid
		Material certificate from supplier
Defects	Surface and internal defects	Manufacturing of steel lid
		Material certificate from supplier

Figure 5-2. Production-inspection scheme for the steel lid. Blue colour is used for processing of the design parameter and orange for inspection, darker colour illustrate final processing or inspection.

Prop-erty	Design parameter	Manufacturing of steel tube cassette	Casting of insert	Machining	
Material composition	Cu, C, Si and Fe content in nodular cast iron		Casting		
			Material analysis (molten metal)		
Material properties	Ultimate tensile strength (R_m) Fracture toughness Yield strength (R_e) Elongation		Casting		
			Tensile testing (cast on bars)		
			Tensile testing bars from top)		
Dimensions	Total length		Casting	Machining	
	Outer diameter		Conventional techniques	Conventional techniques	
	Bottom thickness				
	Outer corner radius		Manufacturing of tubes		
	Wall thickness		Material certificate from supplier		
	Inner width, inner length		Manufacturing of cassette	Casting	
	Straightness		Gauging	Gauging	
	Distance between channel tubes		Manufacturing of cassette	Casting	
	Conventional techniques	Conventional techniques (top/bottom)			
	Edge distance		Casting	Machining	
			Conventional techniques (top/bottom)	Ultrasonic testing	
Defects	Nodular cast iron Surface and internal defects		Casting	Machining	
				Method not determined (surface defects)	
				Ultrasonic testing (internal and surface defects)	

Figure 5-3. Production-inspection scheme for the insert. Blue colour is used for processing of the design parameter and orange for inspection, darker colour illustrate final processing or inspection.

5.2.2 Manufacturing of steel lid

The steel lids, see Figure 5-4, for the inserts are manufactured from steel plate and delivered to the canister factory complete with final dimensions and holes for the centre screw and the valve. A certificate to verify that the steel lid conforms to the technical specifications follows the delivery. The associated parts, i.e. screw, gasket, valve for atmosphere replacement, etc will also be delivered with similar documentation.

5.2.3 Manufacturing of steel tube cassette

Before the casting of an insert takes place, a steel tube cassette is manufactured which forms the channels, and which in time will accommodate the fuel assemblies, see photo to the right in Figure 5-4. The channels are formed with the aid of square-profiled steel tubes, which are welded together to form a cassette. Information about the steel tubes and cassettes are specified in the technical specifications, which are distributed to the supplier in conjunction with the ordering of an insert.

At this stage of the manufacturing cycle, the straightness of the channel tubes is the most important aspect, as well as the positions of the channel tubes. The channel tubes are inspected to ensure that they are straight before being welded together to form a cassette. They are also gauged both before and after welding in order to make sure that the geometry is correct so that the fuel assemblies can be inserted into the channels. The supplier conducts dimension inspection of the cassette prior to delivery. Once the cassette has been completed, it is dispatched to the foundry to be inserted in the mould.



Figure 5-4. The photo on the left shows part of the machined insert with the notches between the fuel channels, and a steel lid with a hole for the valve for atmosphere replacement and a centre screw. The photo on the right shows a steel tube cassette.

5.2.4 Casting

The inserts are cast with 12 channels for BWR assemblies or 4 channels for PWR assemblies. The cassette with channels is designed in such a way that the inserts are cast with an integrated bottom. Before casting, the steel tubes in the cassette are filled with sand that is compacted. This is necessary in order to avoid deformation of the steel tube walls by compression from the molten metal during casting.

The formwork and method of casting may vary between foundries. Both sand and steel moulds have been used. The filling of the mould with molten iron can take place either by filling the molten metal from the top, referred to as top pouring, or by bottom pouring, whereby the molten metal is led via a channel down into the bottom of the mould. Both methods have been used for the casting of inserts. The filling of molten iron means that the cassette acquires greater lifting strength, which set high demands on the attachments and design of the cassette.

After casting, the insert is allowed to cool in the mould, which takes a few days. The insert is then knocked out of the mould, cleaned and the top of the insert is cut and finished.

SKB has, for several years, been developing the process for the casting of inserts, in collaboration with suppliers. The process has been thoroughly analysed and it has been possible to determine process parameters. Some important parameters in the casting process are: that the right chemical composition is obtained; that the right nodular cast iron treatment is carried out; that slagging is conducted and that the pouring is performed at the right temperature. SKB monitors that these parameters are met. Self-inspection is carried out at the foundries during the various stages of the process.

The inspection programme at the foundries is backed up by extensive knowledge. Self-inspection guarantees that the inserts are manufactured in a reliable way and conform to the specifications of mechanical properties, material structure and material composition defined for the reference insert.

One important measure that has been introduced in the manufacturing process is that the insert is cast with a surplus length in order to be able to cut away a certain section at the top where slag and other impurities gather. The eccentricity of the cassette in the insert is measured at the top and bottom to make sure that the edge distance conforms to the specified value.

Before casting is started, SKB approves a quality plan that has been drawn up by the foundry in question. Prior to approval for the delivery, the documentation is reviewed to verify that the delivered inserts conform to the technical specifications.

5.2.5 Machining

Exterior machining, referred to as pre-machining, of the insert is carried out to facilitate ultrasonic testing of the inserts from the outside. In order to thoroughly clean the channels, it has proved to be an efficient method, during machining, to introduce pieces of metal into each channel which are then allowed to roll around during the machining and thereby remove the sand that has burnt on to the channel surfaces.

When the insert has been delivered to the canister factory and ultrasonically tested, the final machining is conducted.

5.2.6 Inspection of the material composition

Material analysis of the nodular cast iron is performed at the foundries by taking a sample from the molten metal for analysis. If the material composition needs to be adjusted, it is done before casting and a new material analysis is performed. The results of the material analysis are a part of the required documentation from the foundry.

5.2.7 Inspection of the material properties by means of destructive testing

Material properties are inspected by tensile testing of test pieces (cast-on samples) as well as of test pieces that have been extracted from the top of the insert. This latter type of testing is carried out by a third party. Since the cooling velocity is much faster in a small cast-on sample compared with a large volume that incorporates the entire insert, the results from the cast-on samples are only used as an indication that the required type of material is obtained. The samples from the cut off top section verify the conformity to the reference design.

Knowledge of processes and experience from sampling along the entire length of the insert have also shown that, since slag floats upwards, a test plate from the top represents the worst properties in the insert. If the top plate has good properties, the rest of the insert will also have good properties.

To verify that a nodular cast iron has been achieved, the microstructure is evaluated by performing investigations using an optical microscope of the test pieces that displayed the highest and the lowest elongation in each insert. Approved manufacturing quality means that the graphite form for the most part shall be round, (i.e. nodules). This means that the form of the graphite corresponds to Forms V and VI /SKBdoc 1175208/.

5.2.8 Inspection of defects by non-destructive testing

In order to inspect for defects, SKB is developing NDT methods at the Canister Laboratory. On the basis of experience available within industry concerning the NDT of large castings and potential types of defects, volumetric (shrinkage, shrinkage pores, chaplet blowholes, surface flaws, sand and slag inclusions) and crack-like defects, ultrasonic testing has been chosen as the main technique for inspecting the insert. In order to examine the entire volume with sufficient reliability, three different testing areas are defined, see Figure 5-5.

For these testing areas, the following reference methods are currently being tested:

- angle incidence ultrasound testing of the exterior surfaces of the insert (lilac) in order to detect volumetric and crack-like defects,
- normal incidence ultrasound testing of areas between the surface of the insert and the channel tubes (green) in order to detect volumetric defects,
- transmission ultrasound testing of the area between the channel tubes (yellow) in order to detect volumetric defects.

Angle testing of the external surface of the insert is carried out in four directions by means of the Transmitter Receiver Longitudinal technique, a double-crystal probe that generates longitudinal sound waves. This method is used for the testing of reactor vessels within the nuclear power industry. Both normal testing and transmission testing are performed with phased array ultrasonics developed from conventional technology normally used for the testing of various types of castings.

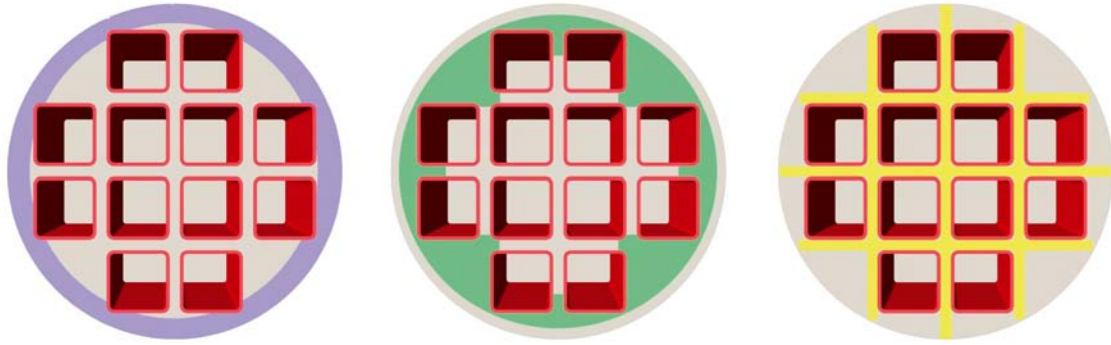

Figure 5-5. Testing areas for BWR insert. The areas investigated with the various methods are angle scanning (lilac), normal scanning (green) and transmission testing (yellow).

Ultrasonic testing that has physical limitations near the surface, and to ensure that the entire volume is inspected, the testing is carried out before the insert is machined to its final dimensions. After final machining, additional surface inspection will be carried out. The method to be used for this inspection as well as the specification of acceptable surface defects shall be established before the manufacturing commences.

A detailed description of the non-destructive testing of inserts is found in the NDT Report /SKBdoc 1179633/.

5.2.9 Dimension inspection

Inspection of the size and geometrical form of trial-manufactured inserts is at present performed at the foundries.

- The manufactured cassette is measured by the manufacturer to verify its conformity to the specified size and shape. The exterior dimensions of inserts (length, diameter and bottom bevelling) are measured after machining by conventional mechanical methods.
- The cross sectional dimensions of the insert channel tubes (length and straightness) are inspected with a gauge in order to ensure that there is enough room for the fuel assemblies. Gauging is carried out both before and after casting.

In order to measure the edge distance between the external corners of the channel tubes and the insert casing surface, use is made of normal testing by the ultrasonic method as described in Section 5.2.8. This measurement is performed before the insert is finally machined and, if the cassette is not centred, it can be adjusted during final machining accompanied by subsequent renewed inspection.

The measuring methods to be used for final dimension inspection of the insert and steel lid shall be determined before the manufacturing commences. During the course of this final dimension inspection, the following parameters will be inspected: external dimensions of the insert, gauging of the channel tube and measurement of edge distance (distance between external channel tube corner and casing surface along the length of the insert).

In order to guarantee reliable non-destructive testing, the insert is inspected with respect to surface roughness.

5.2.10 Results of test manufacturing

In total, 47 BWR inserts and 8 PWR inserts have been test manufactured prior to May 2008. This explains why the development of manufacturing techniques for BWR inserts has reached further than for PWR inserts. During 2007, a series of five BWR inserts were manufactured. In preparation for this series, an extensive study was made of the process. The purpose was to identify all the important process stages and to make sure that relevant routines were in place.

The development of PWR inserts had until 2007 been carried out on a significantly smaller scale. Subsequently, development has been intensified and, as a consequence of the experience gained in the manufacturing of BWR inserts, good progress has been made.

The intention of this section is to verify that manufactured inserts conform to the specifications of the reference design and the technical specifications used for the test manufacturing in the phase of development. The reported results are based on the five BWR inserts manufactured in 2007 and on the three PWR inserts manufactured with the channel tube dimension specified in the reference design.

Material composition

The analyses of the material composition /SKBdoc 1175208/ of the nodular cast iron used for the five serial-manufactured BWR inserts and three manufactured PWR inserts are shown Table 5-1. All the inserts conform to the technical specifications of material composition provided for the test manufacturing.

Material properties

The results of the tensile testing of samples extracted from the top plates of these inserts are shown in Figure 5-6 and Figure 5-7 /SKBdoc 1175208/.

All BWR inserts conformed to the technical specifications for mechanical properties and material structure. The nodularity reached 90% for forms V and VI in all five serial-manufactured BWR inserts, whereas only one of the PWR inserts achieved 90%. The other two PWR inserts were below the specification of 80% and displayed traces of disturbed graphite in their structure. All PWR inserts conformed to the current test manufacturing specification for mechanical properties, even though elongation was on the low side.

Table 5-1. Analysis of material composition (%) in BWR inserts manufactured in a series and three individually manufactured PWR inserts compared to the technical specifications for test manufacturing.

Material	Material composition for nodular cast iron (%)*							
	Cu	C	Si	Mn	P	S	Ni	Mg
Technical specification	≤0.05	3.2–4.0	1.5–2.8	0.05–1.0	≤0.08	≤0.02	≤2.0	0.02–0.08
BWR inserts								
I53	0.037	3.62	2.30	0.16	0.025	0.006	0.40	0.045
I54	0.035	3.64	2.28	0.14	0.027	0.006	0.39	0.044
I55	0.044	3.64	2.34	0.14	0.022	0.008	0.39	0.045
I56	0.048	3.55	2.31	0.17	0.023	0.006	0.39	0.040
I57	0.031	3.66	2.34	0.18	0.023	0.007	0.38	0.044
Mean value	0.039	3.62	2.31	0.16	0.024	0.007	0.39	0.044
Standard deviation	0.007	0.04	0.03	0.02	0.002	0.001	0.007	0.002
PWR inserts								
IP7	0.01	3.39	2.32	0.18	0.038	0.008	0.55	0.036
IP8	0.02	3.43	2.25	0.15	0.042	0.009	0.48	0.044
IP9	0.02	3.41	2.41	0.15	0.034	0.005	0.53	0.057
Mean value	0.017	3.41	2.33	0.16	0.038	0.007	0.52	0.046
Standard deviation	0.006	0.02	0.08	0.02	0.004	0.002	0.04	0.011

* The content of Fe is above 90% in all inserts.

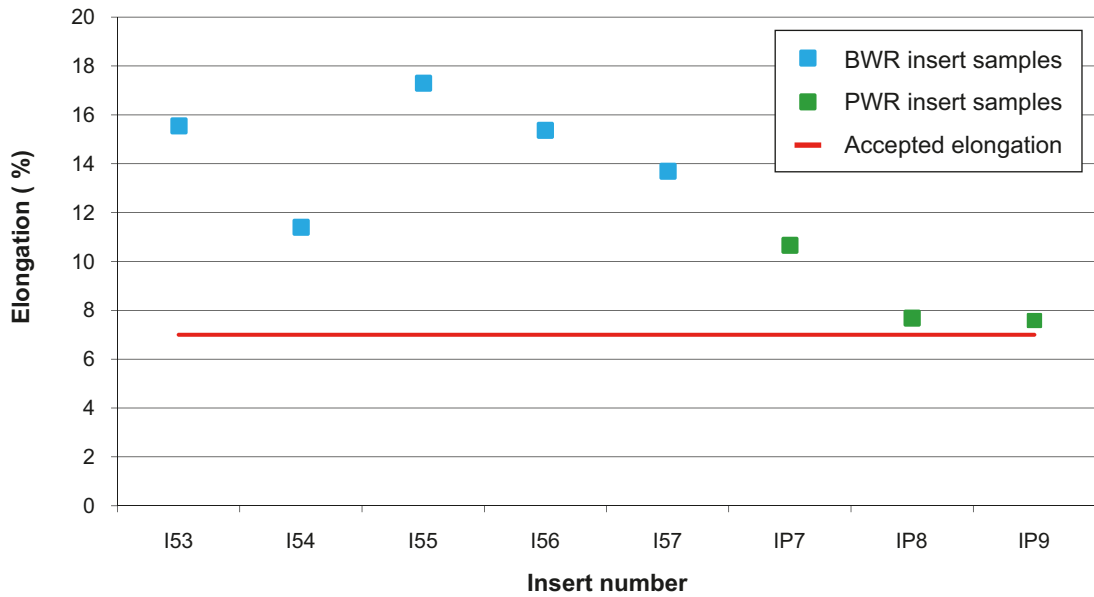

Figure 5-6. Elongation in BWR inserts I53-I57 and PWR inserts IP7-IP9. The data shown represents the mean value of the five best samples of six according to the current manufacturing specification. For tensile test bars extracted from the top plate the accepted value in the technical specifications is 7% (shown as a red line).

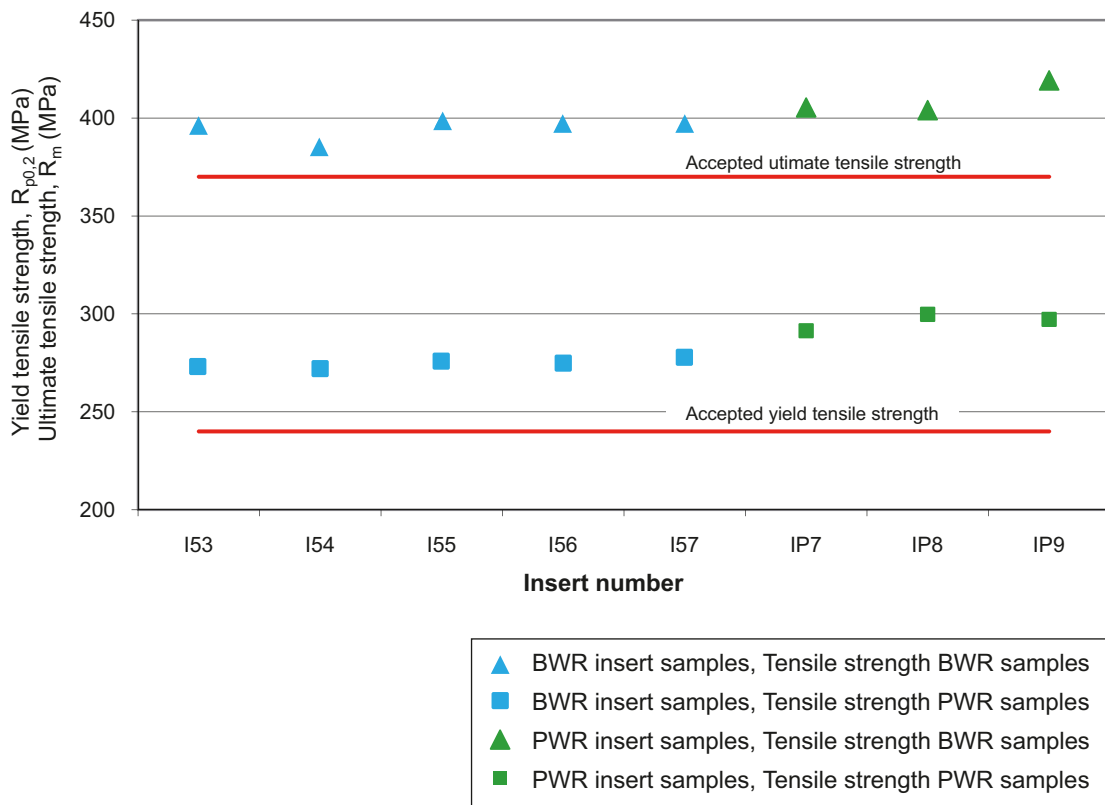

Figure 5-7. Yield tensile strength and ultimate strength in BWR inserts I53-I57 and PWR inserts IP7-IP9. The specified data refers to the five best samples out of six according to the current manufacturing specification. The acceptable strengths according to the technical specifications are shown as solid lines.

In order to further verify the material properties in the BWR inserts, supplementary testing was performed on samples extracted randomly from the middle and bottom of the inserts, respectively /SKBdoc 1175208/. The results of this testing are shown in Table 5-2 and confirm previous experience that the material properties are better and more even in the actual insert than in the top plate. This is most likely because inclusions are lighter than the molten metal and hence forced up to the top section. Removal of the top section of a casting of this size is a normal procedure during manufacturing. This in turn shows that the BWR insert conforms to the specifications of the reference design with a sufficient margin.

The results of the strength tests performed on samples extracted from the top plate of the PWR insert given in Table 5-3 /SKBdoc 1175208/ indicate that all PWR inserts conform to the technical specification with respect to mechanical properties, although the elongation was on the low side.

Occurrence of defects

The above inserts have been tested at the Canister Laboratory with the reference NDT methods described in Section 5.2.8. The results /SKBdoc 1179633/, of these tests have not indicated any major defects, for example no defects were detected during normal scanning of the BWR inserts. On the other hand, angle scanning indicated up to 100 areas in respective inserts with pore clusters. These clusters are estimated, following a number of metallographic investigations, to be ~100 cm³ with a relatively low porosity (~1 ‰), which in total gives a defect volume in the range of ten cubic centimetres in each insert. Since the technique not yet has been developed to compensate for the variations in the position of the channel tubes, the results of the transmission testing have not yet been fully evaluated.

As regards the three PWR inserts that are the subject of evaluation, all of them have been inspected by means of normal scanning, which has revealed to two defect indications of ten millimetres in size. Angle scanning has only been performed on one of these inserts with the result that some ten indications, similar to those in the BWR inserts, have been encountered. The PWR inserts have not been tested with the transmission technique since it has not yet been adapted for this geometry.

Table 5-2. Material properties in five BWR inserts, tensile test bars from top, middle and bottom of the inserts and cast-on samples. Mv = mean value, Stdav = standard deviation.

Parameter	Technical specification	Reference design	Top plate Mv/Stdav	Middle Mv/Stdav	Bottom Mv/Stdav	Cast-on Mv/Stdav
Tensile yield strength ($R_{p0.2-RT}$)	≥ 240 MPa	267 MPa	274.3/2.6	279.1/7.2	274.6/3.1	278.4/4.4
Ultimate tensile strength (R_m)	≥ 370 MPa		391.3/9.8	397.8/4.3	399.6/3.5	417.6/3.5
Elongation (A_{5-RT})	≥ 7%		13.7/3.7	16.3/1.8	17.3/1.6	18.1/1.6
Compression yield strength ($R_{p0.2-RT}$)		≥ 270 MPa	279.8/2.6			
Fracture toughness (J_{2mm-0°)		> 88 kN/m	90.8/(88.1*)			
Fracture toughness (K_{IC-0°)		> 78 MPa√m	79.7/(78.0*)			

* Includes samples from various positions in some inserts, the right value shows the lower 90% confidence level for the population of data /SKBdoc 1207576/.

Table 5-3. Material properties in three PWR inserts. Samples taken from top plate.

PWR insert	Yield tensile strength Rp0.2 (MPa)	Ultimate tensile strength Rm (MPa)	Elongation A (%)
Technical specification	240	370	7
IP7	291	397	10.7
IP8	300	404	7.7
IP9	297	419	7.6

In addition to the above inserts, tests have been conducted on some ten BWR inserts that were manufactured earlier. The results of these tests indicate a similar outcome as for the previous inserts, i.e. only isolated defects have been indicated by normal scanning whereas a large number of pore clusters have been detected with angle testing.

The reliability of the testing methods has been studied in co-operation with BAM (Federal Institute for Materials Research and Testing) in Berlin. The number of actually available defects has been limited for the purpose of these reliability studies. This has meant that the NDT methods have been analysed with respect to detection capacity for artificial defects.

The value “ $a_{90/95}$ ”, which has been used as a reliability measure, means that defects will be detected with 90% probability within a confidence range of 95%, i.e. the level of uncertainty in the determination of detection capacity.

In general terms, it can be stated that the angle scanning which has been examined with respect to notches (simulating crack-like defects) has a detection capacity of 2–3 mm for surface defects and 4–9 mm for defects at 50 mm depth. Normal scanning has been examined with respect to side-drilled holes and is shown in the same way to have a detection capacity that deteriorates with depth and is within a range of 2–8 mm. With this as a starting point, it can be assumed that the NDT methods can detect defects ranging in size from 5 mm down to a depth of 50 mm and 10 mm at greater depths. With this as a basic point of reference, it can be assumed that the number of non-indicated defects larger than 10 mm in size should be very limited.

Dimensions

Information from the dimension inspection is presented in the Manufacturing Report /SKBdoc 1175208/. The gauging inspection was approved for all BWR inserts in the series. A gauge with dimensions of 152×152 mm and approximately 4 m long could be inserted into all the channels. The foundry’s own measurement of eccentricity (carried out at the top and the bottom of the insert) also gave approved results. For PWR inserts, problems have been experienced in gauging with a gauge measuring 226×226 mm in size. For example, only one of these three inserts has met the gauge values. During 2007, the technique of inserting compacted sand into the channels before casting was further developed. When an improved compaction of sand has been used, it has been possible for the channels to be gauged after casting. The problem is now deemed to have been solved, but further means for improvement will be tested.

Since the middle of 2007, it has been possible to measure the distance between the casing surface and the external channel corner (see Figure 3-5 H, edge distance) at the Canister Laboratory by means of ultrasonic testing. In the manufactured series of BWR inserts I53-I57, it was discovered that the cassettes were somewhat “banana shaped”. They conformed to the technical specification of maximum 5 mm eccentricity at the top and bottom, but some of them did not conform to the technical specification along the entire length of the insert. Table 5-4 shows the results of these ultrasonic measurements of the edge distance /SKBdoc 1175208/, where it can be seen that the BWR inserts have varying values. The PWR insert cassettes, on the other hand, are straight since the deviating value for IP7 is mainly attributable to the fact that it was not centred sufficiently during machining.

In order to solve the problem with bent cassettes in BWR inserts, measures have been taken at one foundry involving a change in the design of the downgate from the pouring cup. Initial attempts with this modified pouring cup indicate that it is possible to cast inserts with straight cassettes.

In order to gain an understanding of the accuracy of the measurement method based on ultrasonic testing, the BWR inserts were cut at several positions in order to facilitate conventional mechanical measurement. The results indicate that the method has an accuracy of ± 1 mm. This means that if the inserts are manufactured with a non-approved edge distance, this will be detected by the ultrasonic inspection.

Other cassette dimensions, such as the corner radius of the channel tubes and the distance between the channel tubes are governed by drawing and manufacturing specifications. The channel tubes, which are made of square-profile tubing, are normally ordered by the foundry and the dimensions secured by the supplier.

Table 5-4. Recorded maximal deviation of edge distance in five BWR inserts and three PWR inserts.

Tolerance in edge distance – reference design (technical specification)	BWR inserts	Maximum deviation from nominal edge distance (mm)	PWR inserts	Maximum deviation from nominal edge distance (mm)
± 10 (± 5)	I53	8.1	IP7	5.5
	I54	6.5	IP8	4.0
	I55	3.2	IP9	2.9
	I56	8.0		
	I57	4.9		
	Mean value	6.1	Mean value	4.1
	Standard deviation	2.1	Standard deviation	1.3

External dimensions of the inserts are also inspected at the foundry after pre-machining and are presented in a report from the foundry. The dimensions of the serial-manufactured inserts conformed to the drawing dimensions.

5.3 Manufacturing of copper tubes

SKB has chosen the extrusion method as the reference method for the hot forming of copper tubes. A detailed description of the development of copper tubing is given in the Manufacturing Report /SKBdoc 1175208/.

5.3.1 Production inspection scheme for the manufacturing of the copper tube

To give an overview of the production and how design parameters are processed and inspected a production-inspection scheme (see Section 5.1.4) illustrating the different production stages for the copper tube is given in Figure 5-8.

Property	Design parameter	Casting of copper ingots	Extrusion	Machining
Mat. comp	Standard copper (EU standard) P, S, H and O	Casting		
		Conventional technique (top and bottom of ingot)		
Material properties	Ductility Creep ductility	Casting	Extrusion	
		Visual and penetrant testing (surface defects)	Tensile testing (bars from tube top and bottom)	
	Average grain size		Extrusion	
Dimensions	Thickness	Casting	Extrusion	Machining
		Weighing of ingot	Conventional methods (hole centring)	Method not determined
	Length Inner diameter	Casting	Extrusion	Machining
		Weighing of ingot	Conventional methods (tube round, straightness)	Method not determined
Defects	Surface and internal defects	Casting	Extrusion	Machining
				Method not determined (surface defects)
				Ultrasonic testing (internal and surface defects)

Figure 5-8. Production-inspection scheme for the copper tube. Blue colour is used for processing of the design parameter and orange for inspection, darker colour illustrate final processing or inspection.

5.3.2 Casting of copper ingots for tubes

The casting and machining of ingots as well as the quality control are performed by external suppliers. An ingot intended for the manufacturing of copper tubing can be seen in Figure 5-9. A description of the development of copper ingots is given in the Manufacturing Report /SKBdoc 1175208/.

The production of large ingots is normally carried out by means of semi-continuous casting, which creates a cylindrical and solid ingot. The diameter of the ingot must be sufficiently large to allow the ingot, in the subsequent tube manufacturing, to be upset axially without buckling. The outer surface of the ingot that is to be used for the manufacturing of the copper tubing shall be machined so that the ingot is of the correct weight and its surfaces are clean. In addition, the edges are rounded off before extrusion.

The casting process for copper ingots has been developed by the supplier over the years by making changes in the process. The following improvements have been made: the oxygen content has been lowered, central cracking has been reduced, better control of the phosphorus content has been introduced and the surface quality has been improved.

During casting, the chemical composition of the highly pure copper is determined. In order to improve the creep properties phosphorus is added to the molten metal. This is done by feeding in a wire containing phosphorus. Wire feeding is a common method that is used in the sector for adding alloy substances in a controlled manner. The process is controlled by adjusting the feeding speed of the wire. Checking the content of phosphorus and other substances is done by analysing samples from the bottom and top of the ingot. Initially the process is not stable and the correct chemical composition may not be achieved, therefore 10–30 cm is cut away from the bottom of the ingot. The top of the ingot is also cut so that defects that may have been formed at the top are removed.

During the manufacturing of ingots, the process is controlled to avoid the occurrence of undesirable defects. The supplier conducts self-inspection throughout the process in order to be able to control the casting. After casting, each ingot is marked with a unique identification number to which all documentation concerning the ingot is linked.

In order to make sure that the ingot contains a sufficient amount of material for the subsequent hot forming either the external dimensions of the ingot are inspected by measuring or the ingot is weighed. An ingot will be rejected if its mass is below the acceptance value, which could be a consequence of major surface-breaking defects that require excessive machining.



Figure 5-9. Large copper ingot weighing approximately 12 tonnes.

The ingots are inspected visually by the supplier after the exterior surface has been machined and by SKB at delivery. As a supplement to the visual inspection, penetrant testing of the ingot end surfaces is also carried out on the supplier’s premises in order to detect the possible presence of central cracks in the casting. Currently experience from the trial manufacturing is gathered, this includes determination of acceptable cracks. The ends of the ingots have in recent years had high quality and it has not been possible to detect any defects in finished tubes with NDT in the latter stages.

Destructive testing has not been carried out on the material properties of the copper ingots since these properties are determined by the subsequent hot forming.

5.3.3 Extrusion

The choice of extrusion as the reference method is based on its high level of repeatability, i.e. it is robust and automated with few process parameters. In addition, the method has a high capacity and low probability of creating defects, and it delivers tubes with satisfactory material properties.

Extrusion is initiated by preheating the copper ingot, after which it is compressed axially to increase the diameter before being pierced by forcing a mandrel through the ingot, see Figure 5-10. The pierced ingot, called a blocker, is then machined in order to make sure that the hole is centred in the blocker and that all relevant dimensions are correct prior to the final extrusion. For the extrusion of tubes in the sizes required by SKB, a large press needs to be used in which the tube is forced vertically upwards. The dimensions of the tubes are determined internally by a stationary mandrel and externally by the diameter of the matrix in the press instrument, see Figure 5-10.

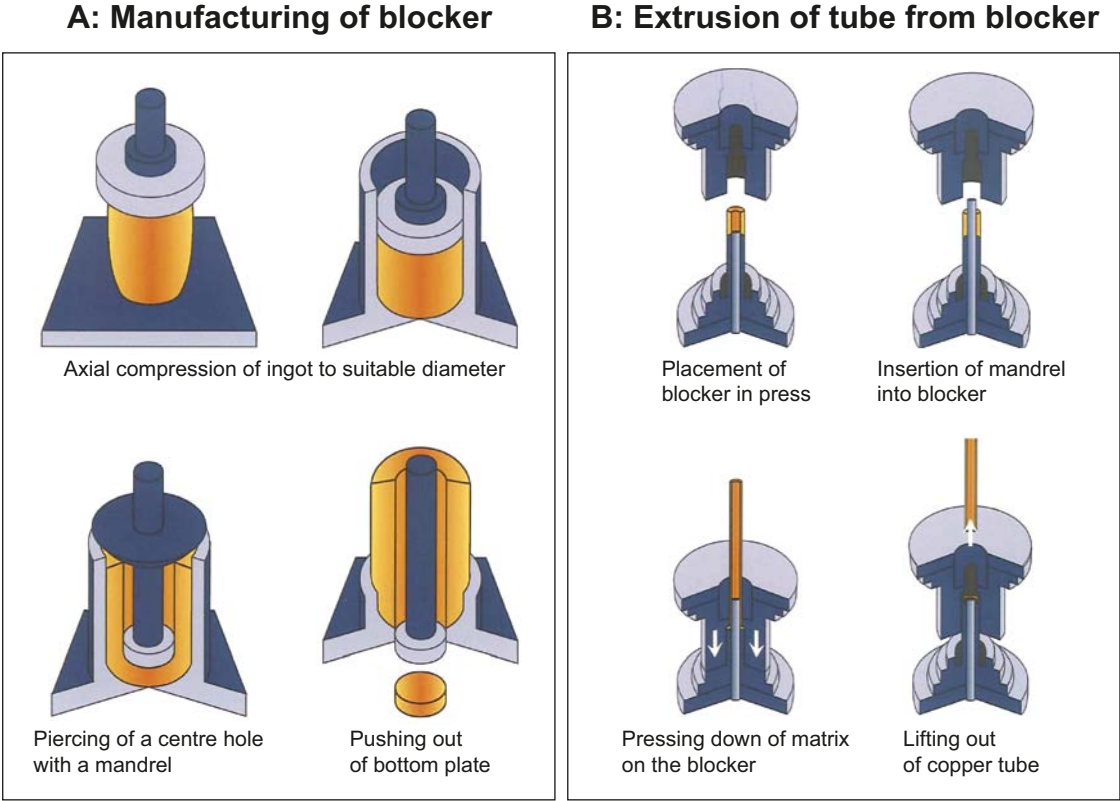

Figure 5-10. Schematic illustration of the extrusion process, including the manufacturing of a blocker and the extrusion of the tube.

After re-heating, the blank is placed in the press. The mandrel together with the matrix forms a ring-shaped extrusion throat through which the copper blank is forced at great pressure. This gives rise to a major deformation of the material which results in the material acquiring the required properties. Following extrusion, the tube is marked with a unique manufacturing number, which is linked to the copper ingot that was used to manufacture it. Figure 5-11 shows the extrusion of a tube. Before the tube is sent for machining, it is measured above all for straightness, but also for roundness in order to check whether it conforms to the technical specifications for the machining process.

During the course of the various process stages, it is primarily the material properties and structure of the copper material that are influenced. The major deformation creates a fine-grained material, and since the tube cools relatively quickly after the extrusion no major increases in grain size have time to develop. This gives an average grain size that conforms to the technical specifications.

Shrinkage defects, like cavities, may occur during solidification of the ingot but will be compressed at the high temperature in following operations. Defects that break the surface could be exposed to oxygen that forms an oxide film on the surface of the defect. This oxide film may cause oxide stringers in the extruded tube. There are evidences that the defects will be located in the central part of the ingot and are removed completely during the piercing operation when the blocker is formed in preparation for the extrusion. This has been studied in the pierce and draw process where the piercing is stopped at certain depth to accomplish an integrated bottom in the following draw process. Traces of defects have been found and simulation shows that the origin of the defects is the bottom.

Defects are also forced out towards the outer surface of the tube, and most likely disappear during the subsequent machining. SKB has not detected any interior defects in extruded copper tubes during ultrasonic inspections. This indicates that the manufacturing process works well provided that the ingots are clean to start with and surface-breaking defects, indicated by the penetration testing, are machined off from the ingots before the manufacturing of blockers.

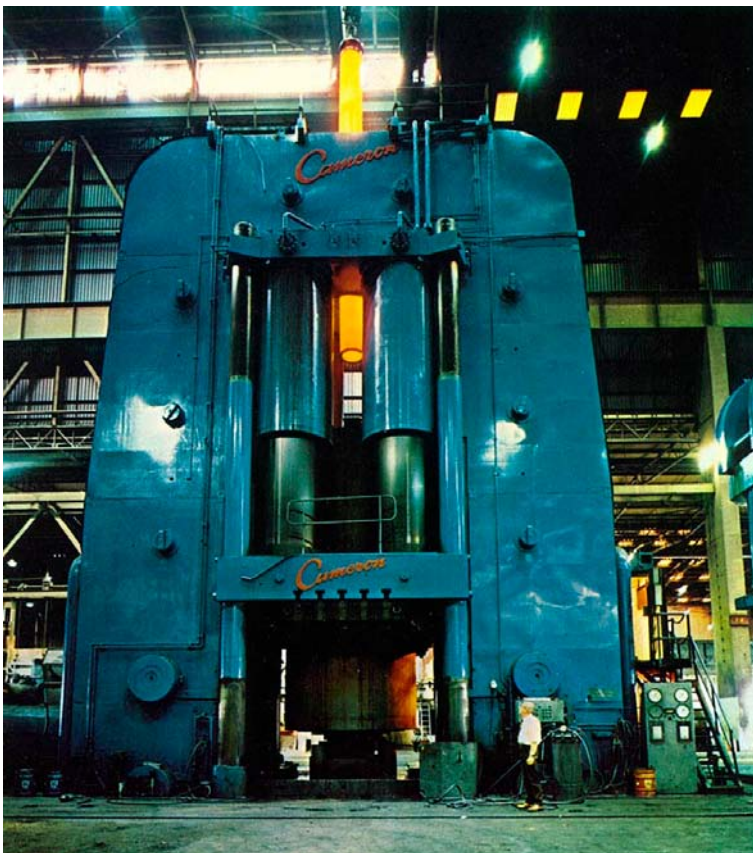

Figure 5-11. The photo shows the extrusion of a tube.

5.3.4 Machining

Machining is performed in two stages: pre-machining and final machining. Pre-machining involves finalising the internal diameter of the tube and machining the other surfaces in order to permit ultrasonic testing and to make sure that the tube can be completed to the specified dimensions.

Once the copper tube has been delivered to the canister factory and has been ultrasonically tested, the final machining is carried out to achieve the dimensions specified in the drawings. These will be the final dimensions, whereas the measurements taken previously will serve as self-inspection during the production phase in order to ensure that the final dimensions of the tube will conform to the specified.

5.3.5 Inspection of the material composition

In order to check the chemical composition of the copper tube, samples are extracted for analysis from both ends of the copper ingot after the bottom and top have been cut away. The material analyses are performed at an approved laboratory, either in the supplier's own laboratory or at an external laboratory.

5.3.6 Inspection of the material properties

After the tube has been extruded, samples are taken from its ends in order to verify that the material properties of the tube conform to the specifications for the reference design. These samples are tested as follows.

- Tensile testing to inspect elongation, performed by an approved laboratory in accordance with a well-proven standard.
- Material structure – average grain size is measured in accordance with a well-proven standard. In addition, ultrasonic testing of the tube is used (see Section 5.3.7) to indicate any areas with larger grain sizes.

5.3.7 Inspection of defects by non-destructive testing

For the inspection of defects, SKB is developing NDT methods at the Canister Laboratory. With respect to the possible types of defects such as the formation of oxide stringers and surface scratches and experience from industry relating to the NDT of large tube components, ultrasonic testing has been chosen as the main technique for inspection of the copper tube.

It is most likely that the defects that occur in connection with extrusion will propagate parallel to the longitudinal surface. Hence normal scanning by means of ultrasonic testing, see Figure 5-12, has been chosen as the initial reference method for testing the copper tubes. Normal scanning is performed using phased array technology in order to be able to use an optimised sound field and maximum testing speed.

To ensure that the entire volume is inspected, the ultrasonic testing, that has physical limitations near the surface, is carried out before the copper tube is machined to its final dimensions. After final machining, additional surface inspection will be carried out. The method to be used for this inspection as well as acceptable surface defects will be established before the production commences.

A description of developments in the NDT of tubes is to be found in the NDT Report /SKBdoc 1179633/.

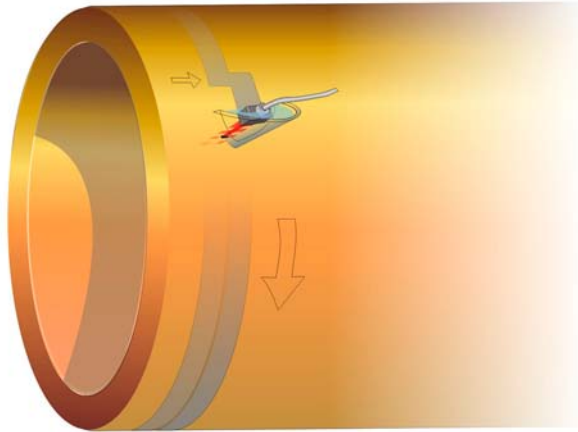

Figure 5-12. Ultrasonic testing of copper tubing by means of normal scanning.

5.3.8 Dimension inspection

The dimensions of the copper tubing are inspected in several stages after extrusion. First the external dimensions, straightness and roundness of the tube are inspected before machining in order to make sure that the tube can be machined to the final dimensions. After this, the tube is pre-machined with subsequent inspection of the internal dimensions before being finally machined to its final dimensions.

The measurement methods to be used for final dimension inspection of the copper tubing remains to be established. During the final dimension inspection, the following will be measured: internal and external diameter, length, thickness of the copper and specific dimensions based on the joint design for FSW.

In order to guarantee reliable non-destructive testing, the tube is inspected with respect to surface roughness.

5.3.9 Results of test manufacturing

During the course of the past ten years, some 40 large copper ingots have been manufactured, and from these, 27 tubes have been extruded. Trial casting has been carried out by means of the semi-continuous casting of ingots which have then been machined to an outer diameter of 850 mm. Over the years, the casting process has been improved. For example, at the beginning of the 21st century, an extensive review was made of the process, which resulted in better control of the phosphorus content, a lowering of the oxygen concentration and a decrease in occurrence of central cracks. During 2004, the capacity of an individual casting was also increased to 16 tonnes, which has meant that the areas in the ends of the ingot, where the risk for defects is increased, can be cut away with a sufficient margin.

As a consequence of this, the results are presented from the 8 tubes that were manufactured 2005–2008 based on ingots manufactured in accordance with the developed casting process.

Material composition

Analyses of the material composition /SKBdoc 1175208/ of ingots that were used for the manufacturing of these 8 copper tubes in accordance with the current specification are shown in Table 5-5. All the ingots conform to the specified material composition.

Subsequent thermoforming is not considered to have any influence on the chemical material composition, which is determined and inspected in connection with the casting of the ingots.

Table 5-5. Material composition (ppm) of copper ingots for copper tubes manufactured over the period 2005–2008. Contents are specified in ppm apart from the Cu content, which is expressed as a percentage. To the right, the mean value (MV) and standard deviation (STD) have been compiled.

Tube no:	Specification	Material composition – large ingot for tubes								MV	STD
		T45	T46	T47	T48	T53	T56	T57	T58		
Man.yr		2005	2005	2005	2005	2007	2007	2008	2008		
Cu	≥99.99	99.99	99.991	99.99	99.99	99.991–99.992	99.991	99.991	99.992	99.991	0.001
P	30–100	71	67–70	66–72	66–72	60–73	67–72	69–88	54–56	68.4	7.8
O	<5	0.8–1.1	0.7–0.9	0.8–1.2	0.8–1.5	1.0–1.8	0.9–1.3	0.5–0.7	1.6–2.4	1.13	0.49
S	<8	4.8	4.7–4.8	4.5–4.8	4.4	5.3–5.7	4.3	4.3	5.3–5.6	4.77	0.47
H	<0.6	0.3–0.4	0.3–0.4	0.4–0.5	0.3–0.5	0.4–0.6	0.43–0.44	0.28–0.50	<0.1	0.37	0.14
Ag	<25	13.0	13.6–14.2	13.2–13.4	13.4–13.5	13.9–14.1	14.9	14.3–15.0	13.2	13.8	0.7
As	<5	0.81	0.78–0.81	0.80–0.83	0.82	0.78	0.96–0.97	0.87–0.99	0.85–0.87	0.85	0.07
Bi	<1	0.114–0.116	0.113–0.116	0.109–0.112	0.119–0.120	0.18–0.19	0.20–0.21	0.15–0.21	0.104–0.117	0.14	0.04
Cd	<1	<0.003	<0.003	<0.003	<0.003	<0.003	<0.003	<0.003	<0.003	<0.003	–
Fe	<10	1.4	1.4–1.5	1.4	1.4–1.5	0.6–0.7	0.2–0.4	0.6–0.7	1.1–1.2	1.06	0.44
Mn	<0.5	<0.1	<0.1	<0.1	<0.1	<0.1	<0.1	<0.1	<0.1	<0.1	–
Ni	<10	0.7–0.8	0.7–0.8	0.8–0.9	0.8–0.9	0.7–0.8	0.4	0.3–0.5	1.1–1.2	0.74	0.24
Pb	<5	0.24	0.24–0.25	0.27	0.27–0.28	0.32	0.25–0.27	0.18–0.26	0.26–0.29	0.26	0.03
Sb	<4	0.054–0.060	0.053	0.053–0.054	0.06	0.11	0.10–0.11	0.08–0.10	0.06	0.072	0.023
Se	<3	0.2	0.2	<0.09	<0.09	0.3	0.4	0.3	0.1–0.2	0.22	0.11
Sn	<2	0.05–0.06	0.05–0.06	0.05–0.06	0.06–0.07	0.09	0.1	0.06–0.07	0.18–0.19	0.084	0.043
Te	<2	0.05	0.05	0.05	0.05	0.06	0.1	0.07–0.11	0.05	0.063	0.021
Zn	<1	<0.1	<0.1	<0.1	<0.1	<0.1	<0.1	<0.1	<0.1	<0.1	–

Material properties

Performed tests of the extrusion method shown that the manufactured tubes conform to the material properties specified for the reference design /SKBdoc 1175208/. The extrusion of copper tubing delivers a ductile material that meets the current specifications for elongation with a sufficient margin. Figure 5-13 shows the measured elongation measured from samples extracted from the bottom of the eight manufactured tubes.

The grain sizes recorded in the ends of the copper tubes show a fine-grained structure that conform to the specified average grain size of < 360 µm, see Figure 5-14 and Table 5-6 where the results of the grain size measurements on copper tubes extruded over the period 2005–2008 are shown.

The creep ductility is determined by means of creep tests carried out over a relatively long time, some tests have lasted a few hours while others have been going on for years /Andersson-Östling and Sandström 2009/. These tests, with creep ductility values above 40% according to Table 5-6, show that the selected copper quality conforms to the specified minimum creep ductility of 15%. No creep testing is performed during the normal manufacturing trials.

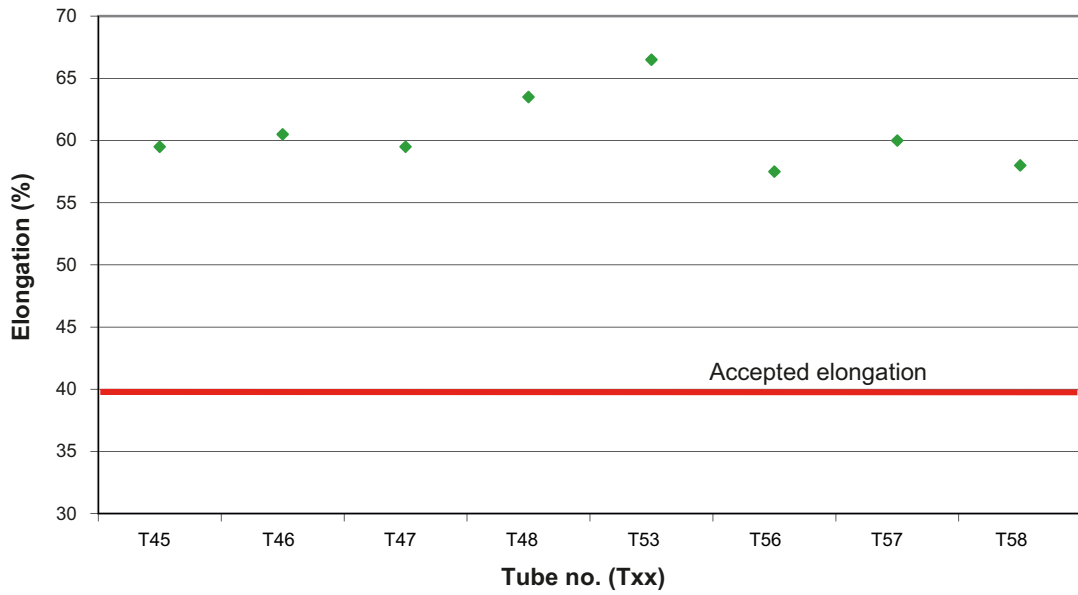

Figure 5-13. Elongation from samples extracted from the bottom of the copper tube (mean value of two samples). The technical specifications for test manufacturing are shown as a solid line.

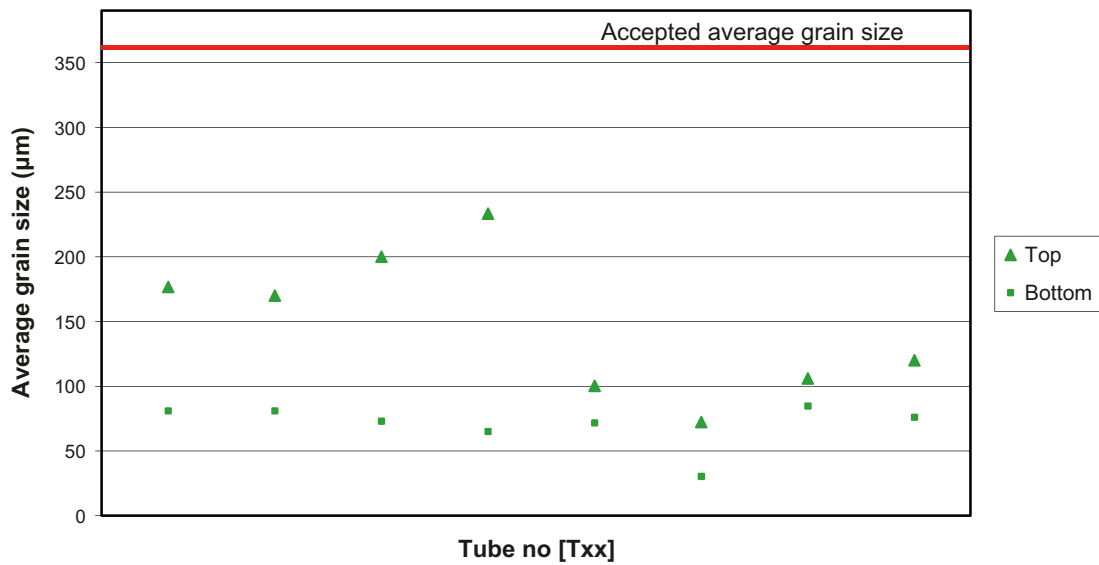

Figure 5-14. Average grain size from top and bottom of copper tube (mean value of three samples extracted along the tube wall thickness).

Table 5-6. Evaluation of mechanical properties and grain size of copper tubes, and a comparison with the specification as per the reference design.

Parameter	Specification	Mean value	Standard deviation
Elongation, bottom (%)	> 40	60.1	2.1
Average grain size, top (µm)	< 360*	156	60
Average grain size, bottom (µm)	< 360*	76	20
Creep ductility (%)	> 15	49.3	3.0

* Preliminary specification set on the basis of testability by ultrasonic testing.

During the ultrasonic testing of copper tubes, areas with higher sound attenuation along certain tubes have been discovered. These areas have been shown to have a larger grain size than the surrounding material. The average grain size in these areas with high sound attenuation is, however, below the accepted 360 μm . As an example, Figure 5-15 shows an ultrasonic result of the latest two extruded tubes T57 and T58, where one of the tubes (T58) shows a typical area with higher sound attenuation (the dark streak). Further studies are in progress regarding these areas. So far, no form of significant impact on the mechanical properties have been demonstrated /SKBdoc 1175208/.

Occurrence of defects

At the Canister Laboratory, the copper tubes mentioned above have been inspected with the reference NDT method described in Section 5.3.7. The results /SKBdoc 1179633/, of these inspections have not displayed any internal defects apart from in Tube T53, where the ingot was prepared with drilled holes in order to provoke defects.

However, these defects were easy to detect because most of them had a spread of several centimetres. A part from one surface-breaking and visible defect, the only surface marks that have been indicated so far are those arising during machining and handling. The surface-breaking defects have, however, a limited radial spread and will thus be removed during the final machining of the tube.

The reliability of the NDT methods has been studied at an initial stage in co-operation with BAM. The number of actually available defects in the tested tubes has been limited for these reliability studies. This has meant that the NDT methods have had to be analysed using artificial defects. The value “a_{90/95}” that has been used as a measure of the reliability means that 90% of defects will be detected within a confidence range of 95%.

In general, it can be stated that normal scanning, which has been studied with respect to flat bottom holes, has a detection capacity within a range of 2–5 mm. With this as a starting point, it can be assumed that NDT can detect defects of 5 mm in size in the copper tubing.

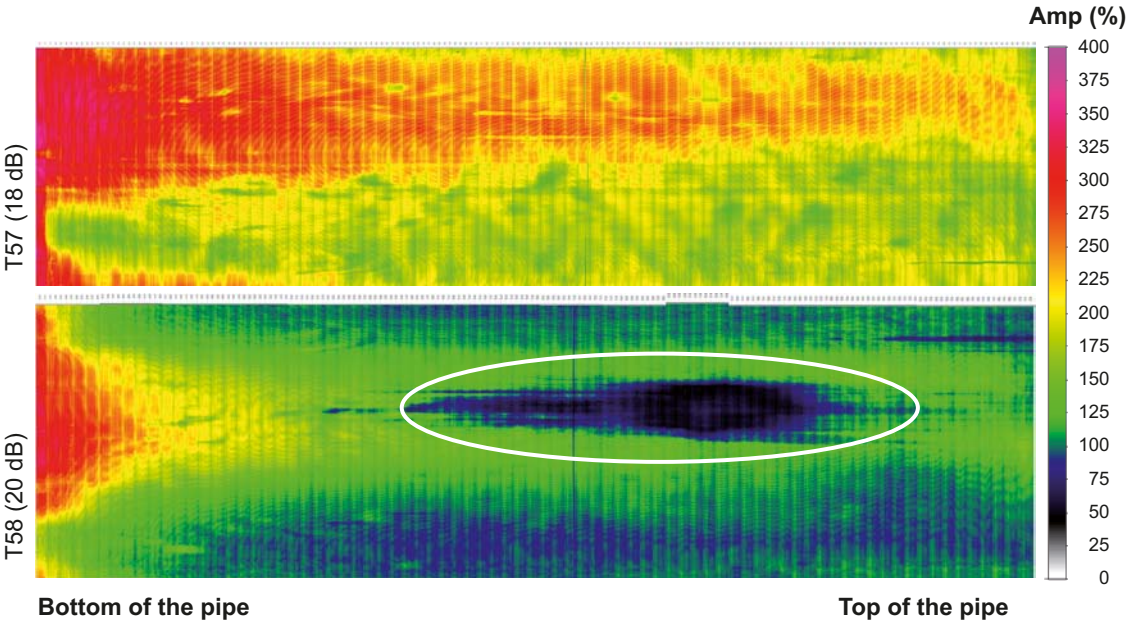

Figure 5-15. Results of ultrasonic testing (C-scan back-wall echo amplitude) from two extruded copper tubes. The horizontal axis represents the length of the tube, i.e. ~5 m, whereas the vertical axis represents the circumference of the tube. The circled area shows a section with a higher level of attenuation (15 dB lower back-wall echo amplitude).

Dimensions

When developing a technology for the extrusion of copper tubing, one problem encountered has been that the tubes were not straight enough, which made it impossible to machine them to the right dimensions. As a consequence of this, an extended guide tube was manufactured for use in the extrusion of copper tubes.

Of the eight tubes that were tested /SKBdoc 1175208/ only the last two were manufactured with this guide tube. The results of the measurement of these tubes indicate, however, a distinct improvement in the straightness of the tubes.

The nominal copper thickness of the tube is 49.0 mm. When considering the accepted variation for the reference canister of 0.3 mm and the expected uncertainty in the dimension measurements of 0.3 mm, the minimal copper thickness of the tube is 48.4 mm.

5.4 Manufacturing of copper lids and copper bases

For the manufacturing of lids and bases in copper, SKB has chosen hot forming by forging as the reference method. A detailed description of the development of lid and base manufacturing is to be found in the Manufacturing Report 2008 /SKBdoc 1175208/.

5.4.1 Production inspection scheme for the manufacturing of the copper lids and bases

To give an overview of the production and how the design parameters are processed and inspected a production-inspection scheme (see Section 5.1.4) illustrating the different production stages for the copper lids and bases is given in Figure 5-16.

Property	Design parameter	Casting of copper ingots	Forging	Machining
Material composition	Standard copper (EU standard) P, S, H and O	Casting		
		Conventional technique (top and bottom of ingot)		
Material properties	Ductility Creep ductility		Forging	
			Tensile testing (bars from periphery)	
	Average grain size		Forging	Machining
Dimensions	Thickness Radial dimensions Axial dimensions	Casting	Forging	Machining
		Conventional methods	Conventional methods	Conventional techniques Ultrasonic testing
Defects	Surface and internal defects	Casting (defects)	Forging	Machining
		Visual and penetrant testing (surface defects)		Method not determined (surface effects) Ultrasonic testing (internal defects)

Figure 5-16. Production-inspection scheme for the lids and bases. Blue colour is used for processing of the design parameter and orange for inspection, darker colour illustrate final processing or inspection.

5.4.2 Casting of copper ingots for lids and bases

The casting and machining of ingots, and the associated quality inspections, are carried out by SKB's suppliers. A description of the development of copper ingots is found in the Manufacturing Report 2008 /SKBdoc 1175208/.

Copper ingots for lids or bases are manufactured by means of continuous casting, which means that from one individual batch of molten metal a large number of ingots are obtained when the main billet, after casting, is cut to the required sizes. Continuous casting is a conventional industrial process. The dimensions for the small ingots are included in the supplier's standard product range, which has facilitated the production of small ingots. The ingot diameter is selected to be sufficient to allow axial upsetting during the subsequent hot forming process.

During casting, the chemical composition is determined. The copper quality is oxygen-free copper. Only phosphorus is added in order to improve the creep properties. Phosphorus is added to the molten metal by feeding it in via a wire.

During the manufacturing of ingots, careful process control is needed in order to avoid the occurrence of undesirable defects. The supplier conducts self-inspection throughout the process in order to control the casting. The casting speed is an example of a parameter that is important for continuous casting. An excessively high speed could mean that the shell of the billet does not have time to solidify sufficiently and the molten metal runs out into the casting bay. An excessively low casting speed could result in over-casting and cause the molten metal to run outside the mould. An uneven speed could lead to surface defects on the billet, when the solidified crust is mixed with new molten metal.

After casting, each individual ingot is marked with a unique identification number to which all documentation concerning the ingot is linked. The ingot is inspected by measuring the external dimensions and by visual inspection of the surface. No destructive testing of the material properties is carried out since they are influenced by the subsequent hot forming.

5.4.3 Forging

The forging is based on a copper ingot, the weight of which is adapted to suit the forging tool. The tool that is used has a geometry which allows the finished blank to be further machined into a lid or a base that can be welded to the copper tube by means of friction stir welding, see Section 5.5.

The manufacturing begins with the ingot being axially upset in order to break down its casting structure and to redistribute material to the periphery of the tool. Figure 5-17 shows one of the stages in the forging process when a rounded tool is used. The process is then completed with forging out in order to fill in the imprints left by the tool. Altogether, the various stages of the forging give rise to a significant deformation of the material, which results in the material having small grains and a high ductility. On completion of the forging, the blank is marked with a unique manufacturing number that is linked to the copper ingot that was used for the manufacturing. Before machining, the blank is inspected to verify that it conforms to the shape specified for the machining.

The continuous casting process is such that slag and other defects are concentrated at the ends of the billet, which are cut away, before the billet is cut into ingots. Consequently, ingots that are used for the forging of lids and bases are normally considered to be pure.

However, defects such as slag inclusions and oxidised cavities or cracks that may remain in the ingot before forging, probably change shape but remain in the lid or base after forging and can only be discovered by means of subsequent NDT.



Figure 5-17. Forging of a lid blank.

5.4.4 Machining

The machining of blanks into lids and bases is performed in two stages with intermediate non-destructive testing. In the first stage, the geometry of the blank is adapted to obtain as good preconditions as possible for non-destructive testing with respect to geometry and finish. Pre-machining also provides information on whether the lid or the base can be machined to the specified dimensions during final machining. In the final machining, the lid/base is machined to the dimensions specified for the following friction stir welding on to the copper tube.

On completion of machining, the lid/base is visually inspected. Figure 5-18 shows a copper ingot, a forged lid blank (before machining) and a lid machined for NDT. The lid/base is marked with its specific number, which has accompanied it from the ingot stage.



Figure 5-18. The photo on the left shows a small copper ingot and a forged lid blank. The photo on the right shows a machined lid.

5.4.5 Inspection of the material composition

In order to inspect the chemical composition of the copper lid and base, material analyses are performed on samples cut out from the original billet. The material analysis is conducted at an approved laboratory, either the supplier's own or an external.

After hot forming, no further testing is carried out because neither forging nor machining is considered to have any major impact on the material composition.

5.4.6 Inspection of the material properties

In connection to the machining, rings are cut from the periphery of the blank. From these rings, random samples are extracted. The samples are then used to inspect the material properties of the lids and bases. The material is inspected as follows.

- Tensile testing in order to check for elongation, performed by an approved laboratory in accordance with a proven standard.
- Material structure inspection of average grain size. In addition, ultrasonic testing is used (see Section 5.4.7) in order to detect any areas with larger grain sizes in the blanks.

5.4.7 Inspection of defects by non-destructive testing

Development at the Canister Laboratory is conducted on the assumption that the copper lids and bases will be inspected by NDT primarily with respect to the occurrence of defects. From an NDT point of view, the lid can be divided into two parts as shown in Figure 5-19; the inner thinner area (a) with a geometry similar to the copper tube and the outer thicker area (b, c). On this basis, reference methods are tested, all based on normal scanning by means of ultrasonic testing with immersion technology.

In the inner part of the lid phased array ultrasonic testing is used to detect oxide stringers, slag inclusions and forging laps, i.e. the same method as for the copper tube is applied. The same technique is also used in the external part of the lid. The difference is that testing in the outer part is performed both from the top surface of the lid and from the surface of the casing.

To ensure that the entire volume is inspected, the ultrasonic testing, that has physical limitations near the surface, is carried out before the copper lid is machined to its final dimensions. After final machining, additional surface inspection will be carried out. The method to be used for this inspection as well as the acceptable surface defects will be established before the production commences.

A detailed description of the development of NDT of copper lids and bases is given in the NDT Report 2008 /SKBdoc 1179633/.

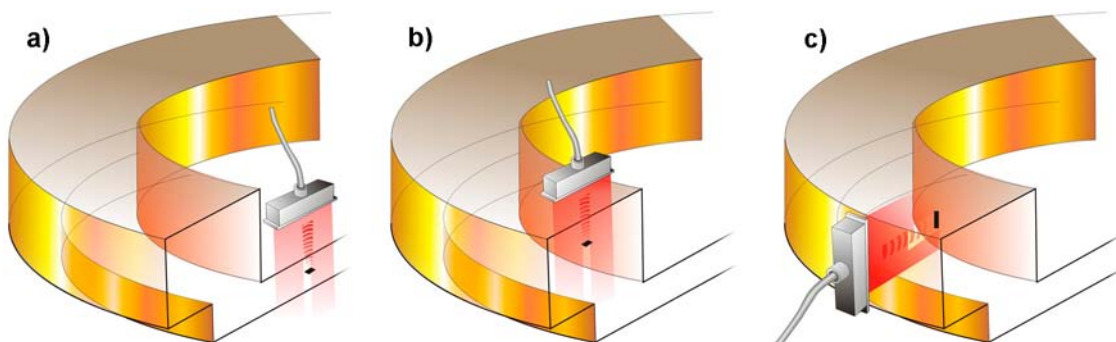

Figure 5-19. Ultrasonic testing of copper lid/base.

5.4.8 Dimension inspection

The external dimensions of the copper lid or base are inspected after pre-machining, in order to guarantee that the lid can be machined to the specified dimensions. The lid and base dimensions are also inspected after final machining, in order to verify that they conform to the dimensions specified for the reference design.

The measurement methods to be used for inspection of the final dimension of the copper lid and base remain to be determined. During the course of this inspection, the following will be included: axial and radial dimensions, thickness of the copper, flange radius and specific dimensions for joint forming for FSW.

In order to guarantee reliable non-destructive testing, the lid or base will be inspected with respect to surface roughness.

5.4.9 Results of test manufacturing

In connection to the trials of techniques for ultrasonic testing of copper lids, variations in sound attenuation have been found in some lids. The variation in sound attenuation indicates a varying grain size as a consequence of a not optimised forging process. As a consequence of this, a series of tests were performed during 2007 in which a statistical experiment design, in the form of a reduced factor test, was used for the forging of ten lids.

Based on the results of this series, process parameters were determined that were subsequently used in the manufacturing of a demonstration series of ten lids. The outcome of this series has shown that blanks can be produced in a satisfactory way. The ten lids in the demonstration series serve as a basis for the following summary.

Material composition

Results from analyses of the material composition of the ingots that were used for the manufacturing of these ten copper lids conform to the technical specification, and are shown in Table 5-7 /SKBdoc 1175208/. All the ingots conform to the material composition specified for the reference canister.

Table 5-7. Material composition (ppm) in small copper ingots manufactured during 2007 for the forging of ten lids in a series. Contents are specified in ppm with the exception of Cu-concentrations, which are given as a percentage. To the right, a compilation is given of mean value and standard deviation.

	Specification Values in ppm (except Cu)	Material composition – small ingots for lids and bases			
		Ingot No. TX207–TX209	Ingot No. TX210–TX216	Mean value	Standard deviation
Cu	99.99%	99.99	99.99	99.99	0
P	30–100	57–70	43–60	57.5	11.2
O	<5	1–2	1–2	1.5	0.6
S	<8	6	6	6	0
H	<0.6	<0.6	<0.6	<0.6	–
Ag	<25	12	12	12	0
As	<5	<1	<1	<1	–
Bi	<1	<1	<1	<1	–
Cd	<1	<1	<1	<1	–
Fe	<10	<1	<1	<1	–
Mn	<0.5	<0.5	<0.5	<0.5	–
Ni	<10	2	2	2	0
Pb	<5	<1	<1	<1	–
Sb	<4	1	1	1	0
Se	<3	<1	<1	<1	–
Sn	<2	<0.5	<0.5	<0.5	–
Te	<2	<1	<1	<1	–
Zn	<1	<1	<1	<1	–

The subsequent thermoforming is not considered to influence the material composition, which is established and inspected during casting of the ingots.

In order to verify the homogeneity of the continuously-cast blanks, the material composition has also been investigated by taking samples from all ten lids. The results /SKBdoc 1175208/ of these analyses, given in Table 5-8, show values well within the specification except for the hydrogen content that is close to the accepted value. The reason for this will be further investigated.

Material properties

The manufacturing trial using forging has shown that lids with material properties that conform to the properties specified for the reference can be manufactured /SKBdoc 1175208/. The forging of copper lids delivers a ductile material that meets the current specifications for elongation with a sufficient margin. Figure 5-20 shows the measured elongation from samples extracted from the ten manufactured lids. All lids have areas in which a certain amount of cold processing has been performed. This can be seen in Lid TX214 from the lower elongation value.

The measured grain sizes in the copper lids indicate a fine-grained structure that meets the specification of < 360 µm, see Figure 5-21 and Table 5-9 where the results of grain size measurement in copper lids forged during 2007 are shown. The ultrasonic testing carried out showed that the lids had a homogeneous material structure.

Table 5-8. Analysed material composition in ten forged lids.

Material	Specification	Mean value	Standard deviation
Cu	> 99.99%	99.992	0.001
O	< 5 ppm	2.24	0.31
H	< 0.6 ppm	0.53	0.11
P	30–100 ppm	52	10
S	< 12 ppm	6.5	0.2

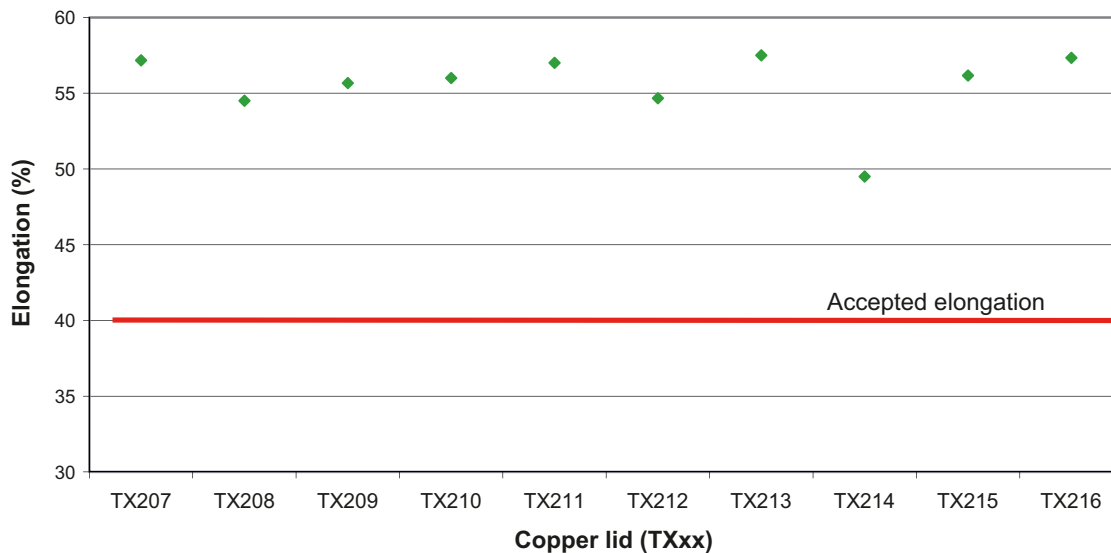

Figure 5-20. Elongation in a demonstration series of ten copper lids manufactured during 2007. The technical specifications is shown as a red solid line.

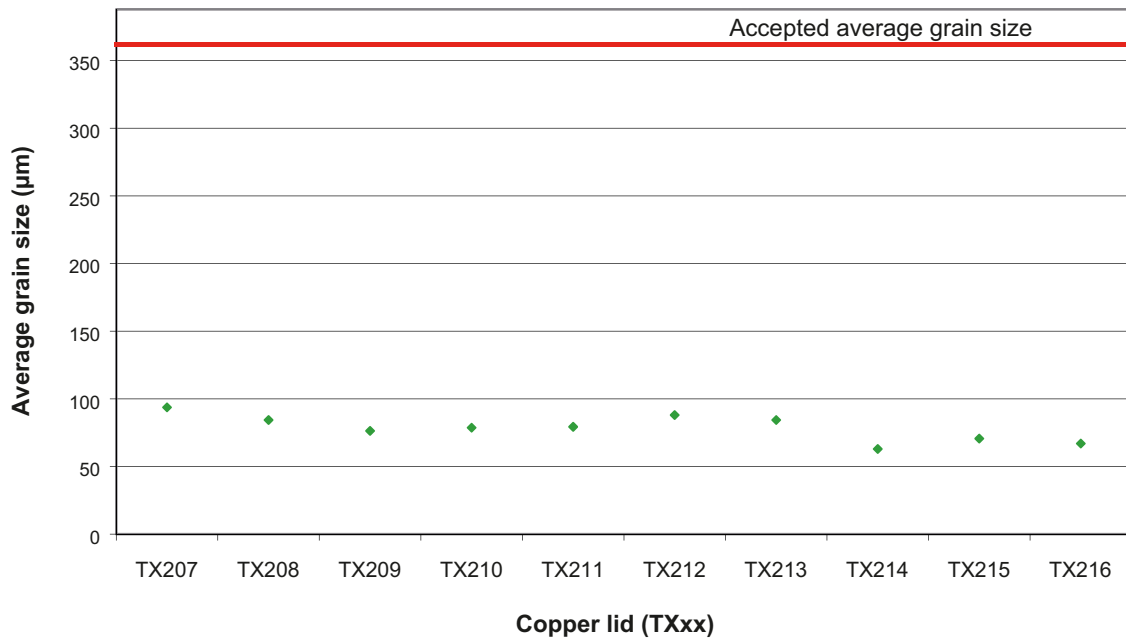

Figure 5-21. Average grain size in a demonstration series of ten copper lids manufactured during 2007.

Table 5-9. Evaluation of mechanical properties and grain size of copper lids and a comparison with the reference design specification.

Parameter	Specification	Mean value	Standard deviation
Elongation (%)	> 40	55.6	4.1
Average grain size (µm)	< 360*	79	15
Creep ductility (%)	> 15	45.9	3.6

* Preliminary specification set on the basis of ultrasonic testability by ultrasonic testing.

The creep ductility is determined by means of creep tests carried out over a long period of time /Andersson-Östling and Sandström 2009/. These tests, with creep ductility values above 40% according to Table 5-9, show that the selected copper quality meets the demands of minimum creep ductility of 15%. No creep testing is performed during the normal manufacturing trials.

Occurrence of defects

At the Canister Laboratory, the copper lids in the test series and the subsequent demonstration series have been inspected with the reference NDT methods described in Section 5.4.7. The results of these inspections have indicated only one defect that was found to be a surface-breaking forging lap /SKBdoc 1179633/.

The reliability of the testing methods has been studied in a trial stage in co-operation with BAM. The number of actual available defects in the copper lids has been limited. This has meant that the NDT methods have had to be analysed using artificial defects. The value “a_{90/95}” that has been used as a measure of reliability means that 90% of defects will be detected with a confidence range of 95%.

In general, it can be concluded that the testing methods which have been examined with respect to flat bottom holes have a detection capacity within a range of 2–5 mm. With this as a starting point, it can be concluded that NDT can detect defects in the copper lids of 5 mm in size.

Dimensions

After final machining all 10 lid conform to the specified dimensions.

The nominal copper thickness of the lid and base is 50.0 mm. When considering the accepted variation of 0.6 mm (lid) or 1.0 mm (base) as given by the reference canister and the expected uncertainty in dimension measurements of 0.3 mm, the minimum copper thickness of the base is 48.7 mm whereas the value for the lid is 48.1 mm under the identity marking of the canister which is 1 mm deep.

5.5 Welding of bases

The reference method for the welding of the bases of the canister is the same as for the sealing of the canister, i.e. friction stir welding (FSW). Welding of the bases is carried out at the canister factory while welding of the lids (sealing) is performed at the encapsulation plant (see Chapter 6). A detailed description of the development work for FSW up to and including 2008 is given in the Welding Report /SKBdoc 1175162/ and the Reliability in Welding Report /SKBdoc 1175236/.

5.5.1 Production inspection scheme for the welding of the copper base

To give an overview of the production and how design parameters are processed and inspected a production-inspection scheme (see Section 5.1.4) for the welding of the bases is given in Figure 5-22.

During the process of welding of the copper bases, the weld properties are determined and the occurrence of defects inspected. The material composition is determined primarily from the basic material but can be influenced by the welding process, for example by carryover of trace impurities from the welding tool and changes in the oxygen content. Before the welding is initiated, it is important to make sure that the jointing surfaces of the base and the tube are clean.

Property	Design parameter	Base welding	Machining
Material composition	Standard copper (EU standard) P, S, H and O	Welding	
		Destructive testing in development phase	
Material properties	Ductility	Welding	
	Creep ductility	Destructive testing in development phase	
	Average grain size	Welding	
Dimensions	Thickness	Welding	Machining
	Radial dimensions	Conventional methods	Conventional methods
	Axial dimensions		
Defects	Surface and internal defects	Welding	Machining
			Method not determined (surface defects) Ultrasonic testing, X-ray (internal defects)

Figure 5-22. Process-inspection scheme for the welding of copper bases. The production stages in which the design parameters are processed and inspected are shown in the figure. Blue colour is used for processing of the design parameter and orange for inspection, darker colour illustrate final processing or inspection.

5.5.2 Friction stir welding

At the beginning of 2002, a welding machine was ordered from ESAB AB in Laxå designed for full-scale welding, see Figure 5-23. A detailed description of the welding machine and its functions is given in the Welding Report /SKBdoc 1175162/. The welding machine at the Canister Laboratory is designed for welding in air, however to investigate the effect on the welding process and the weld zone properties welds in Argon gas have been produced using a provisional gas chamber.

Before the welding is started, an inspection is made to ensure that the joint surfaces of the base and the tube are not damaged in any way and they are cleaned in order to reduce the probability of defects and impurities in the weld.

The welding tool, consisting of a conical probe and a cylindrical shoulder, is an important component in the FSW of copper, see Figure 5-24. The tool must withstand high process temperatures and the high loads to which it is subjected during the welding. A nickel-based super alloy (Nimonic 105) is used as the material for the tool probe. Nickel-based alloys have good high-temperature properties with ample strength against wear and sufficient strength to permit the sealing of canisters. The tool shoulder is manufactured from a Tungsten alloy (Densimet) with suitable thermal and mechanical properties for the process. The tool probe and shoulder are replaced after each weld in order to avoid fractures occurring in the tool probe and to increase the repeatability between welding cycles.



Figure 5-23. Welding machine.



Figure 5-24. Welding tool.

During welding, the rotating tool is forced down into the weld metal. The function of the probe is to heat up the weld metal by means of friction and, through its shape and rotation, force the metal to move around its form and create a weld. The function of the shoulder is to heat up the metal through friction and to prevent it from being forced out of the weld.

The method has few process parameters, which is illustrated in Figure 5-25. The welding tool rotates with a specific number of revolutions per minute and moves along the direction of the weld at a constant speed. The position of the tool shoulder in relation to the canister surface is subsequently controlled by a specific welding force.

During welding, both the input parameters (spindle rotation, welding speed and welding force) and the resulting parameters (depth of the shoulder into the weld metal, temperature of the tool, torque of the spindle engine and the force on the tool in the direction of travel) are registered.

There is a clear connection between the input parameters and the resulting parameters. The product of the spindle rotation and the spindle torque is the power input, which has a significant influence on the temperature of the tool. These relatively elementary relationships mean that the process is easy to interpret, develop and control.

A welding cycle can be divided into several sequences which can be seen in Figure 5-26. First, a hole is drilled 75 mm above the weld line which the rotating tool is then forced into so that the copper is heated up. When the temperature of the tool has reached a specific level, the welding speed is accelerated to a constant value. After the acceleration sequence has been completed and the temperature of the tool has reached the required equilibrium temperature and has become stable, the tool is moved down to the joint line. Here, joint line welding is carried out. After a complete rotation, the tool is moved up 75 mm where the welding cycle is completed and the unavoidable exit hole is formed when the tool is extracted from the canister. Both the acceleration sequence and the exit hole are then machined away when the base is given its final dimensions.

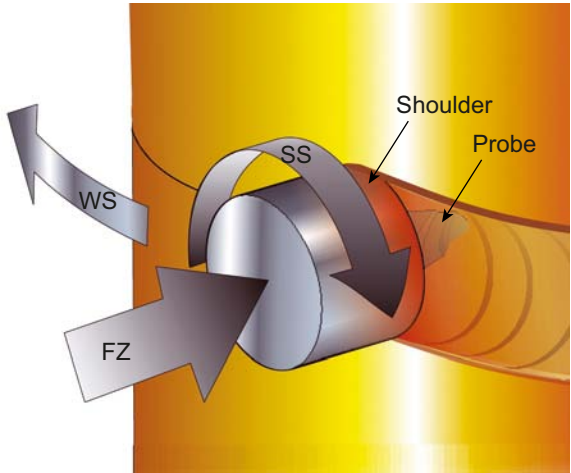

Figure 5-25. Welding parameters – spindle rotation (SS), welding force (FZ) and welding speed (WS).



Figure 5-26. Sequences in the welding cycle: 1) acceleration sequence, 2) downward sequence, 3) joint line welding, 4) overlap sequence and 5) parking sequence.

The acceleration sequence is important because it affects flash formation and the probability that defects are formed during the downward sequence. The remaining sequences, No 2–5 in Figure 5-26, are carried out in a steady-state sequence where all parameters maintain a relatively constant value.

5.5.3 Machining

After welding, the base is machined to its final dimensions. Machining of the copper canister weld surface and of the extended base flange can be performed using the same equipment for external machining as for the copper tubing. Both the acceleration sequence and exit hole are machined away in this stage.

5.5.4 Welding process control

The welding process is controlled to make sure that it has been conducted within verified parameters. For this purpose, a process window has been defined which must be met in order for a weld to be considered approved. The term process window in this context means the permitted range within which input parameters and output parameters are accepted to vary without the welding result being impaired, see Table 5-10. Because the welding process has relatively few process parameters, it has been proved possible to both control and monitor them. The process is normally very reliable with a high level of repeatability, which is explained by the fact that the process is adaptive, i.e. the important tool temperature is measured constantly and the input parameters are adjusted in order to keep the temperature within a given range.

5.5.5 Inspection of defects by non-destructive testing

Developments at the Canister Laboratory have included thorough inspections of the occurrence of defects in base and sealing welds by means of NDT. Based on the experience gained over a number of years of full-scale welding trials, two types of defects have been identified: joint line hooking and wormholes, see Figure 5-27. In order to detect these, the following reference methods have been tested, see Figure 5-28.

- Ultrasonic testing using a phased array technique from the top of the base for the detection of joint line hooking and wormholes (a).
- Digital radiography for the detection of wormholes (b).

The possible defects in the weld (FSW) could be oriented in different directions. Therefore, the phased array technique is used in order to direct the sound at several angles to clearly detect the normally occurring joint line hooking and possible wormholes. At present, this wormhole testing is supplemented by radiography because it has a somewhat higher detection capacity than the ultrasonic testing technique that is used today.

As a complement to the above testing, some form of inspection will be carried out on the weld surface. The method to be used for this type of inspection as well as the acceptable surface defects will be established before the production commences.

A description of developments in the NDT of welding can be found in the NDT Report /SKBdoc 1179633/.

Table 5-10. Parameters in the process windows and the influence of the parameters on the process/welding quality.

Parameter	At high value	At low value
Spindle rotation (rpm)	Risk of high tool temperature	–
Welding force (kN)	Risk of high tool temperature	Risk of defects
Tool temperature (°C)	Risk of tool failure	Risk of defects
Shoulder depth (mm)	Risk of defects	Risk of defects

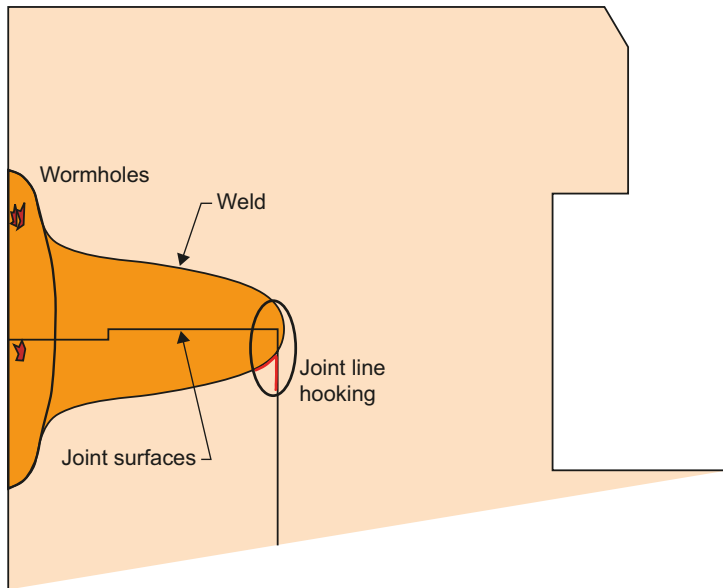

Figure 5-27. Possible defects in friction stir welds.

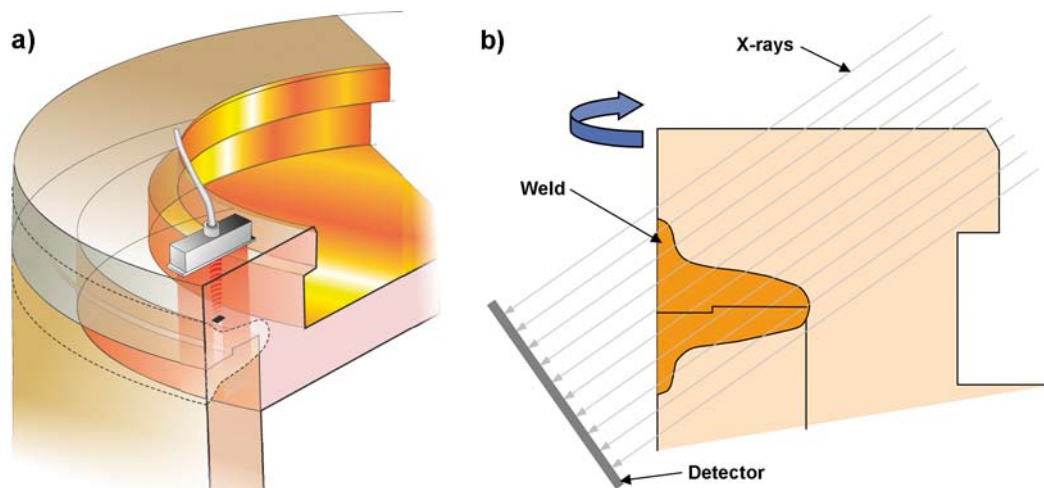

Figure 5-28. Non-destructive testing of FSW. The diagram on the left shows ultrasonic testing schematically, whereas the diagram on the right illustrates radiography.

5.5.6 Dimension inspection

After the welds have been machined, the external diameter and the base flange height are inspected. The measurement methods to be used for the inspection of final dimensions after machining remains to be determined.

In order to guarantee reliable non-destructive testing, the base will be inspected with respect to surface roughness.

5.5.7 Results of welding tests

An extensive testing programme has been conducted at the Canister Laboratory in order to establish the performance of the welding machine and the welding process with a focus on capacity, availability and reliability. Among other aspects, the process has been developed with the aid of a statistical experiment design in the form of factor trials. On the basis of these trials, a process window was defined which was used in a demonstration series consisting of 20 welds performed under realistic

production conditions at a rate of one lid per day. In order to optimise the process, these tests have been supplemented by new factor trials and demonstrations on a smaller scale. All these trials are presented in a separate document /SKBdoc 1175236/.

The following sections summarise the outcome of investigations conducted on welds in the above-mentioned demonstration series. In order to study the material composition and properties of the weld material, tests have been performed on material from welds included in the demonstration series carried out at the Canister Laboratory.

Welding process

The process has been evaluated for the above demonstration series /SKBdoc 1175162, 1175236/. As an initial comment, it can be stated that it has been possible to conduct all the welds without interruption, which indicates a robust welding system. Each weld has been evaluated with respect to whether or not the process parameters have been met. Figure 5-29 shows weld data from the steady-state sequence (Sequence 2–5 in Figure 5-26) for a lid weld (weld ID KL155), which is equivalent to a stretch of 390 degrees and 45 minutes. The temperature of the tool varies between 835 and 860°C, which are well within the margin for the defined process window of 790–910°C.

The results of the demonstration series are presented in overall terms in Table 5-11, which indicates the stability of the process and the fact that the process parameters lie within the process window in all welds.

Table 5-11. Compilation of weld data from all 20 lid welds (FSWL22-41) in the demonstration series.

Parameter	Window	Min. value in respective weld		Max. value in respective weld	
		Mean value/ Absolute min	Standard deviation	Mean value/ Absolute max	Standard deviation
Spindle rotation (rpm)	350–450	368.6/352	11.4	431.8/444	11.5
Welding force (kN)	78–98	80.9/79.4	1.0	93.2/95.5	1.5
Tool temperature (°C)	790–910	829.5/798	10.0	873.9/899	8.2
Shoulder depth (mm)*	0.4–1.5			1.1/1.6	0.2

* Shoulder depth is only measured in one position.

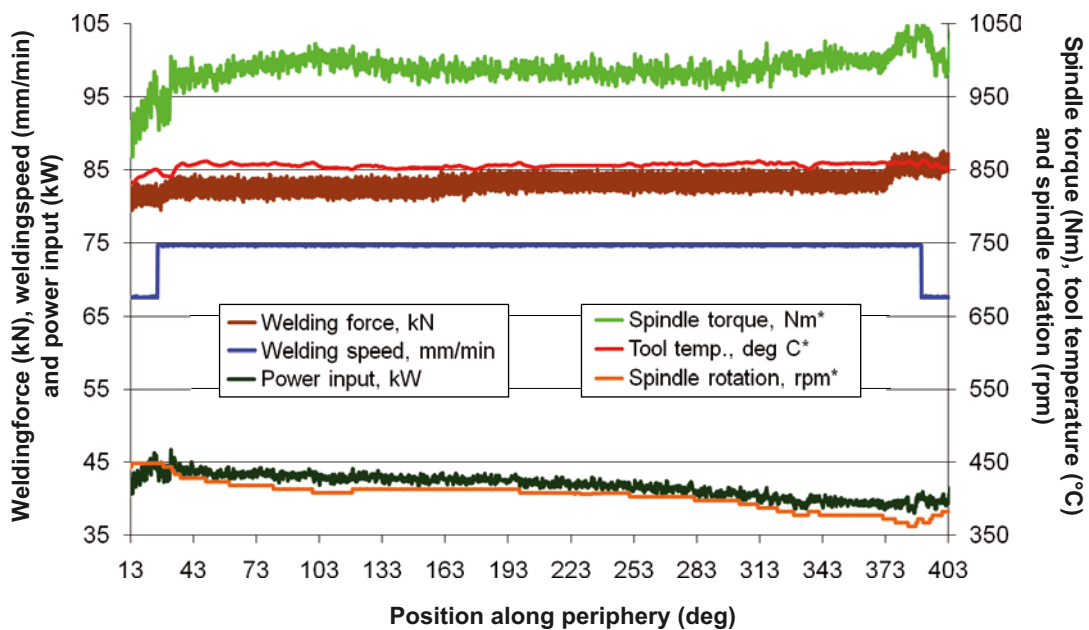

Figure 5-29. Weld data from lid weld. * indicates the value of the higher y-axis. The x-axis indicates the position along the periphery in degrees.

Material composition

The material composition in the welds has been examined in six samples taken from three welds from the demonstration series and in three samples from one weld produced in argon atmosphere /SKBdoc 1175162/. These results are shown in Table 5-12, and indicate that the welds conform to the reference design, apart from some deviation in oxygen content.

In addition to oxygen, the welds also include traces of tool material. A clear reduction of this contaminant has been seen by introduction of a tool with PVD coating of chromenitride (CrN). The levels of Ni, Co and Cr are all less than 1 ppm to be compared to the mean levels (with standard deviation) when using non coated tools (18 samples from 3 welds) of Ni, Co and Cr that were 6.0 ± 6.8 ppm, 1.8 ± 2.8 ppm and 1.6 ± 1.8 ppm respectively /SKBDoc 1175162/.

Material properties

The material properties in the welds have been examined in some ten samples extracted from the demonstration series /SKBdoc 1175162/. The samples were taken from various positions (overlap and joint line) in the welds for which different parameter settings within the process window had been noted.

The results from measured elongation are shown in Figure 5-30, and the results from grain size in Figure 5-31. In Table 5-13, these results are compiled. They indicate that the material conforms to the specifications for the reference design with respect to elongation. The measured average grain size in the weld material indicates a fine-grained structure, which conforms to the specified maximum average grain size of $< 360 \mu\text{m}$ with sufficient margin.

Table 5-12. Analysed material composition in three friction stir welds (FSWL 27, 35 and 36) from demonstration series and oxygen content from one weld (FSWL 51) produced in argon atmosphere.

Material	Specification	Mean value	Standard deviation
Cu (%)	> 99.99	99.99	0
O (ppm)	Up to some tens	11.1 (1.8)*	12.2 (0.4)*
H (ppm)	< 0.6	0.31	0.09
P (ppm)	30–100	56	5
S (ppm)	< 12	4.4	1.2

* Values within brackets are from three samples taken from the weld (FSWL51) produced in argon atmosphere.

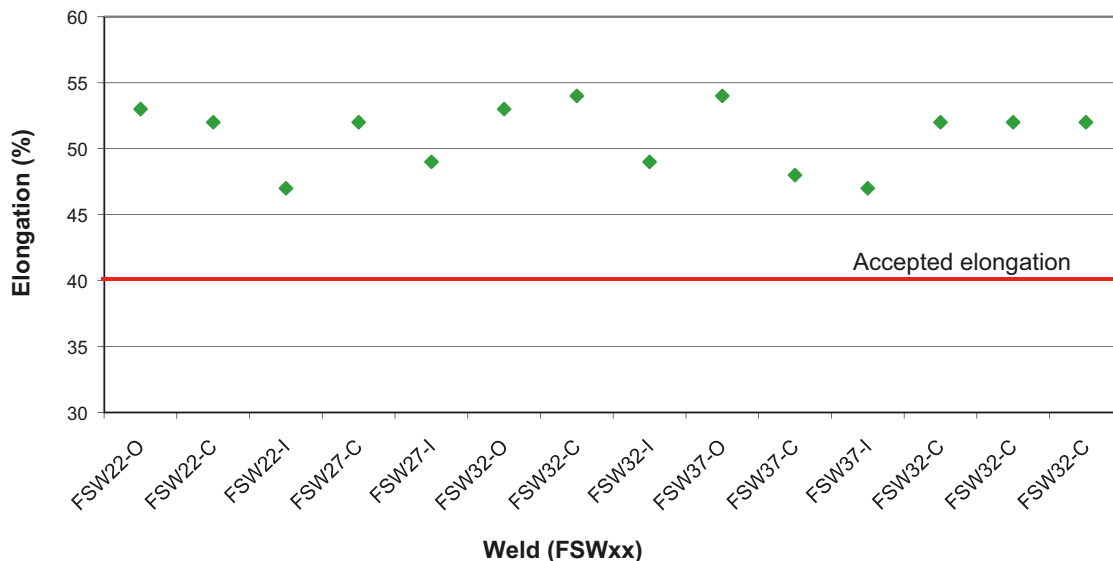

Figure 5-30. Elongation in four welds (three positions/weld) from the demonstration series.

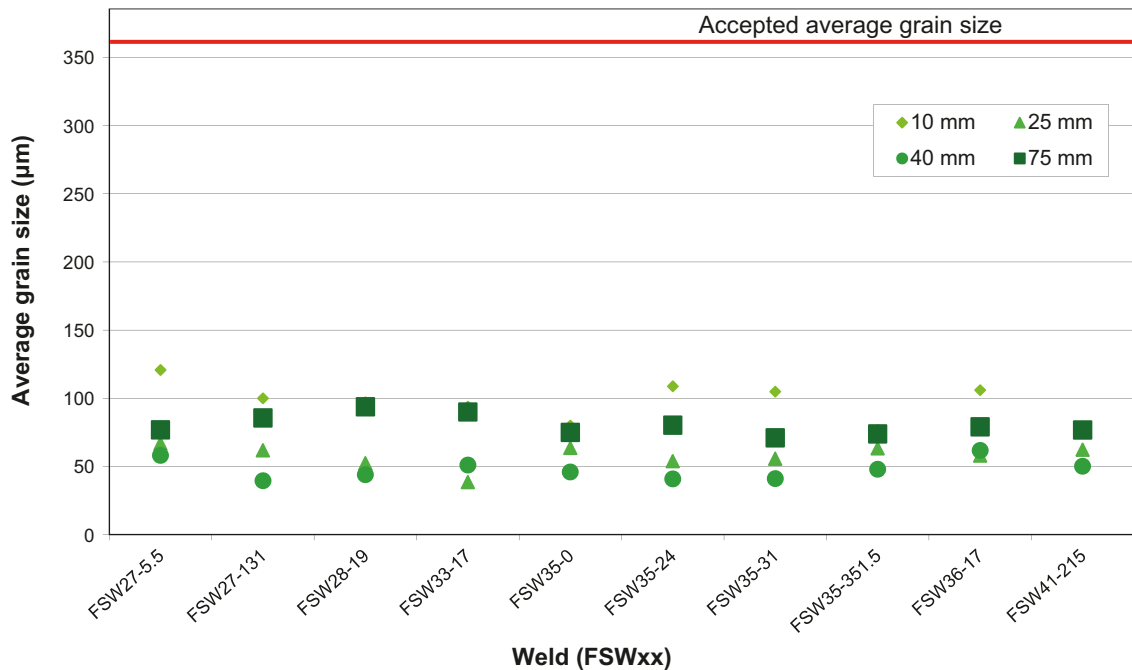

Figure 5-31. Average grain size in 6 welds (a total of 10 positions from the demonstration series). The different series indicate values 10, 25 and 40 mm from the surface of the canister and a reference value from the lid (75 mm).

Table 5-13. Evaluation of mechanical properties and grain size in base welds and a comparison with the specification for the reference design.

Parameter	Specification	Mean value	Standard deviation
Elongation (%)	> 40	51.0	2.5
Average grain size, 10 mm from the surface (µm)	< 360*	88.5	15.1
Average grain size, 25 mm from the surface (µm)	< 360*	54.7	8.2
Average grain size, 40 mm from the surface (µm)	< 360*	47.4	7.4
Creep ductility (%)	> 15	47.1	11.1**

* Preliminary specification set on the basis of testability by ultrasonic methods.

** The relatively high standard deviation is due to creep tests at different temperatures are compiled.

The creep ductility is determined by means of creep tests carried out over a long period of time /Andersson-Östling and Sandström 2009/. These tests, with creep ductility values above 30% according to Table 5-13, show that the selected copper quality conforms to the specified minimum creep ductility of 15%. No creep testing is performed during the normal manufacturing trials.

Occurrence of defects

At the Canister Laboratory, welds are being tested with the reference NDT methods described in Section 5.5.5. The results /SKBdoc 1179633/ of these tests have only indicated the type of defect known as joint line hooking in welds with parameters within the process window. For definition of the joint line hooking defect, see Figure 5-27.

In the first demonstration series, defects were detected by ultrasonic testing. The defects showed a radial size of 1.4–5.4 mm in the following destructive testing. In the subsequent series with an optimised tool the defects were measured to be 0.4–1.5 mm /SKBdoc 1175236/. The observed extension of this kind of defect in the tangential direction (i.e. not in the direction of the corrosion barrier) is most likely some decimetres but it cannot be excluded that its extension could be along the whole weld.

During the course of individual welding trials intended to test different parameters outside the process window, or with a non-optimised tool design, wormholes with a radial extension of up to 10 mm have also been found. To summarise, these demonstrations have shown that the only regularly recurring type of defect – joint line hooking – can be restricted to a radial extension of a few millimetres.

The reliability of the testing method has been studied in co-operation with BAM. These analyses have been performed on the basis of results from ultrasonic testing and radiography that have been compared with the actual result of destructive testing. The value “ $a_{90/95}$ ” which has been used as a measure of reliability means that 90% of defects will be detected to a confidence range of 95%.

In general, it can be stated that ultrasonic testing has a capability to detect joint line hooking defects of the order of 4 mm in size. It should, however, be observed that joint line hooking has a favourable geometry for ultrasonic testing and that defects with a radial extension of less than 4 mm can be frequently detected. In the case of wormholes, the analyses indicate that defects of approximately 6 mm in size for current ultrasonic testing techniques and 4 mm for radiography can be detected.

The occurrence of oxides in the weld zone are reported in Table 5-12. No effect of oxides or tool remnants on corrosion properties have been reported during corrosion tests /SKBdoc 1175162/. No effects on mechanical properties like ductility and tensile strength have been seen. Effects on creep properties are currently being investigated. It should be noted that several lid welds have recently been produced in argon atmosphere to investigate the effects of the argon gas on the welding procedure and the weld zone. In this work other factors that can influence the oxide content are also investigated.

Dimensions

Machining of the weld area is considered to be an uncomplicated procedure and thus means that it should be possible for the dimensions of the reference canister to be achieved. For the purpose of final dimension inspection SKB intends to develop methods for use in the canister factory. The outer dimensions can be measured with conventional techniques while the thickness can be measured by ultrasonic techniques.

The nominal copper thickness in the welds is 48.5 mm. When considering the accepted variation given by the reference canister of ~0.7 mm and the expected uncertainty in dimension measurements 0.3 mm, the minimal copper thickness for the weld is ~47.5 mm.

5.6 Assembly of canister

The final stage of canister manufacturing is to assemble the components to a canister. This is performed in the canister factory.

Before assembly, the canister components are cleaned, primarily to remove cutting fluid residues from machining, but also to remove any other impurities. The methods, to be used for, cleaning and subsequent drying remain to be developed.

All components, which arrive to canister factory, are marked with unique identities from earlier manufacturing steps. After each manufacturing step, the marking is repeated on the component. The copper lid is also marked with the specific canister identity number, on the central upper surface of the lid.

5.7 Transport of the assembled canister to the encapsulation plant

The assembled canister is delivered to the encapsulation plant in a transport package. An example of a transport package for empty canisters, with belonging steel lid and copper lid, is shown in Figure 5-32. The transport package will be adapted to short time storage, lift trucks, over head cranes and the vehicle which will be used for the transport. Inside the transport package, the canister is restrained or clamped into a holding frame, which permits it to be lifted up directly to a vertical position for handling in the encapsulation plant.

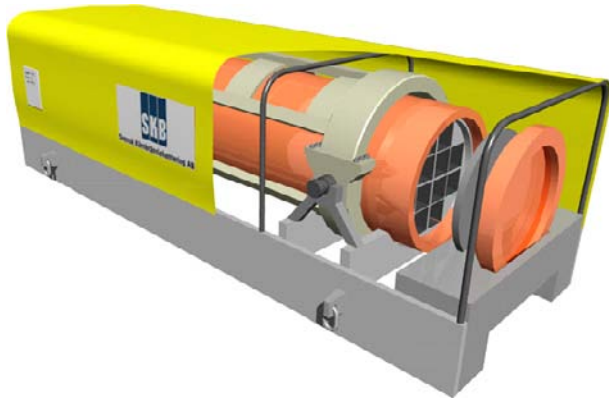

Figure 5-32. A schematic sketch of the proposed transport package for empty canisters.

Detailed solution of how the assembled canister will be transported from the canister factory to the encapsulation plant is depending on the location of the canister factory.

Before transportation of the assembled canister, an acceptance inspection will be conducted to establish the identity of the assembled canister and the identity of the accompanying steel and copper lids. In addition, an inspection will be made to ensure that all documentation on the components is complete and has been approved.

6 Encapsulation, transportation, handling and deposition

This chapter describes the encapsulation of the fuel, transportation, handling and deposition of the canister, see Figure 6-1.

6.1 Overview

The purpose of this chapter is to give an overview of how the encapsulation, transportation, handling and deposition of the canisters in the KBS-3 system are performed and to verify that the deposited canisters conform to the specifications for the reference canister.

Description of the facilities and the main activities are provided in the safety reports for the facilities, see Section 1.3.2. The encapsulation, transportation, handling and deposition of the canister shall at normal operation and expected events, be such that the canister can be deposited. To ensure that the canister with the encapsulated spent fuel conforms to the specification for the reference design the canister is inspected in the different facilities and in connection with the transportation.

If the canister does not conform to the inspection acceptance criteria it will be returned to the encapsulation plant for further investigations.

SKB has carried out a study that describes the events during the handling in Clink, transportation, handling and deposition of the canisters in the final repository facility that may lead to leakage of radioactivity during the operation period /SKBdoc 1191524/. The events that could occur in the facilities and during transportation that could impair the design parameters of the canister are at this stage not finally determined.

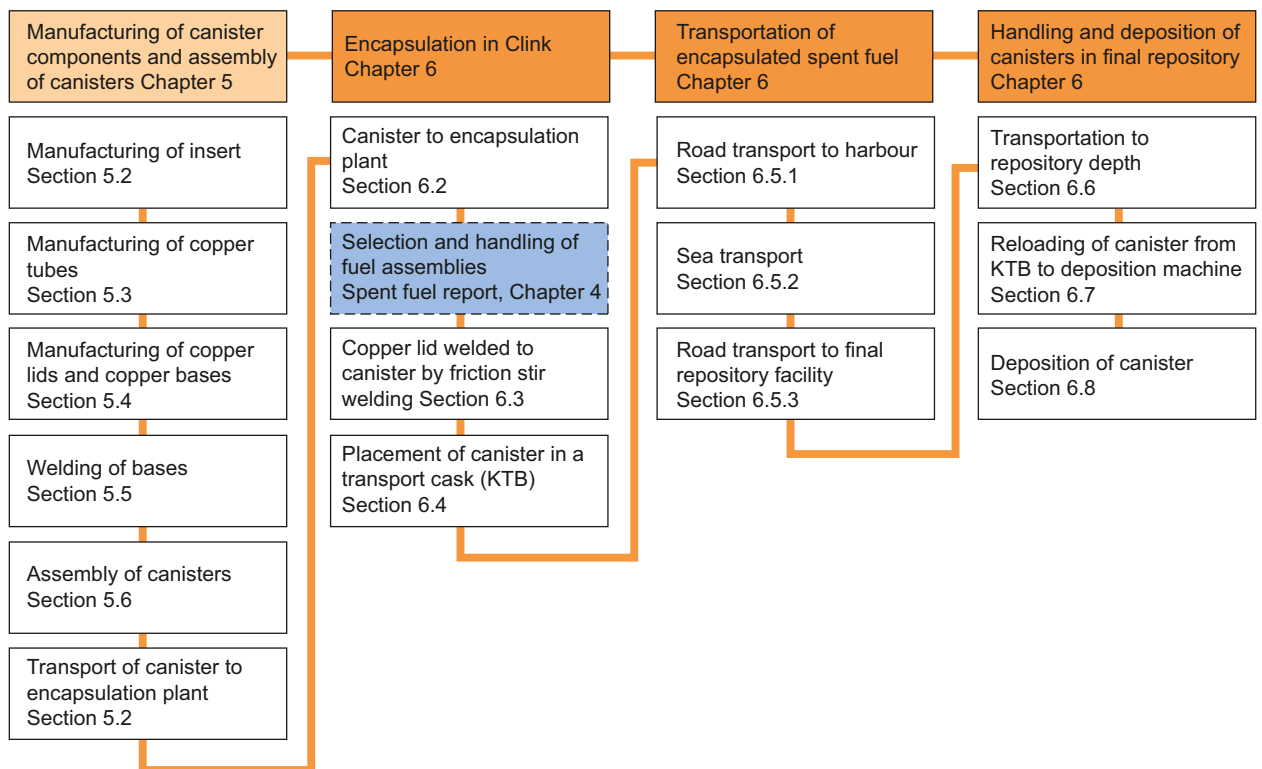

Figure 6-1. The main parts of the canister production line (orange) and flow chart for all stages, including references to the sections in the text where they are described. The main parts presented in this chapter are highlighted.

6.1.1 Encapsulation

The encapsulation of spent nuclear fuel is performed in the encapsulation plant. The nuclear fuel assemblies are selected and dried before they are placed in the canister. Then the insert steel lid is mounted and the atmosphere in the insert is replaced. This is described in detail in the **Spent fuel report**, Chapter 4. Thereafter the canister is sealed by means of a copper lid that is welded to the copper tubing. The welds are inspected before the canister leaves the encapsulation plant. When the canister with the encapsulated spent nuclear fuel leaves the encapsulation plant, it shall be ready to be transported to the final repository facility for deposition.

6.1.2 Transportation

It is the task for the transportation system to move canisters with spent fuel from the encapsulation plant to the final repository facility. The transportation system is responsible for the canister from the point when the transportation package with the canister receives its departure inspection and leaves the encapsulation plant, until it is received at the final repository facility and the acceptance inspection of the package and transport documentation has been completed. SKB currently runs established transport operations in co-operation with the Swedish nuclear power plants and Studsvik. The transportation of encapsulated fuel requires new permits and licences.

6.1.3 Handling and deposition

Inside the final repository facility, the canister is transported down to repository depth and moved to a deposition machine that will place the canister in deposition hole. The transportation of the canister through the repository facility is described in Figure 6-2.

6.2 Canister to encapsulation plant

6.2.1 Delivery and placement in position for placing the fuel

The empty canisters are delivered to the encapsulation plant from the canister factory inside a transport package. The canister is fixed in a transport frame to facilitate the lifting of the canister out of the transport packaging. The transport packaging is removed and the canisters are placed in position within the encapsulation plant ready for the insertion of the fuel.

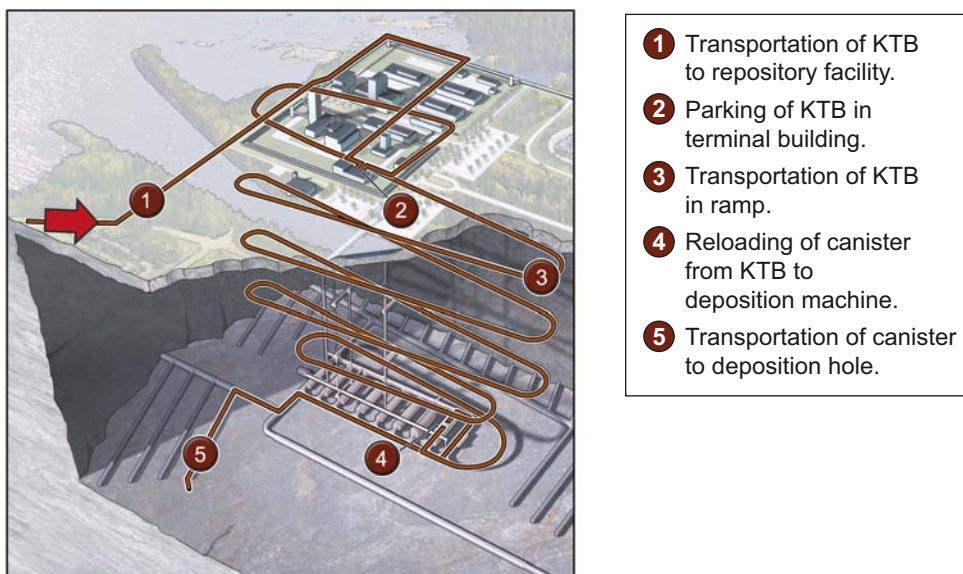

Figure 6-2. Transportation of the canister to and through the repository facility. The canister is placed in a transport cask (KTB) until it is reloaded to the deposition machine in position 4.

The selection and insertion and drying of the fuel assemblies as well as the application of the steel lid and a replacement of the atmosphere in the insert are described in Section 4.8 in the **Spent fuel report**.

6.2.2 Mounting of the copper lid

Once the fuel has been loaded into the canister, the copper lid is cleaned, as necessary, and then placed on the canister. Before the copper lid is put in place, the weld joint surfaces on the lid and copper tube are inspected to ensure that they are clean.

6.2.3 Inspection

The canisters and lids are inspected with respect to identity, documentation, surface damages and cleanness before they are approved for sealing.

6.3 Copper lid welded to canister by friction stir welding

The reference method for the welding of lid is the same as for the welding of the base of the canister, i.e. friction stir welding (FSW). Welding of the lids (sealing) is performed at the encapsulation plant whereas the welding of the bases is carried out at the canister factory. The encapsulation plant is a nuclear facility and the welding, machining and inspections are carried out by remote-control in radiation-shielded rooms. A detailed description of the development work with FSW up to and including 2008 is given in Section 5.5 and in the Welding Report /SKBdoc 1175162/.

6.3.1 Friction stir welding

The welding cycle, see Section 5.5.2, starts when an inlet hole for the welding tool is drilled. The tool is then moved down to the joint line and the lid is welded and after a complete rotation, the tool is moved up away from the welded joint. An unavoidable exit hole is formed when the tool is extracted from the canister. The exit hole is then machined away when the lid is given its final dimensions.

6.3.2 Machining

Machining of the lid weld is performed in the welding and machining station inside the encapsulation plant. The weld is diameter machined until the right dimensions are obtained. Surplus copper material on the upper surface of the lid, where the outlet hole from the friction welding is located, is machined away, see Section 5.5.3.

6.3.3 Welding process control

The most important part of controlling the welding process is to make sure that it has been carried out with weld process parameters that have been verified, see Section 5.5.4. The important welding parameters must lie within the process window if the weld is to be approved. Welds performed outside the process window are rejected.

6.3.4 Inspections

Inspection of defects by NDT

Non-destructive testing (NDT) by means of ultrasonic and radiographic methods are carried out in a purpose-designed station and the testing is carried out both before and after machining, see also Section 5.5.5.

Dimension inspection

After the welds have been machined, the external diameter and the flange dimensions are inspected similar to the process for FSW of the canister base, see Section 5.5.6. The measurement methods to be used for final dimension inspection after machining remain to be established.

Inspection of canister surface

For the canister to be accepted for transportation and deposition in the repository facility it must not be contaminated on the surface. In a station for measurement and decontamination, swab tests are therefore taken to determine whether the canister is surface contaminated.

If the canister is contaminated, mechanical cleaning is carried out. The canister can also be flushed with clean water. After this, new swab tests will be taken in order to verify whether the decontamination was successful.

Inspection of the canister surface is made to ensure that it has not undergone any damage that may be of importance for the function of the canister in the final repository and for its continued handling.

6.4 Placement of canister in a transport cask

The sealed canister is transported to the final repository facility in a canister transport cask (KTB). The transport cask fulfils the criteria for a Type B cask in accordance with IAEA's requirements (*IAEA Safety Standards; Regulations for the Safe Transport of Radioactive Material. Safety Requirements; No.TS-R-1*). The cask is made of carbon steel and cast iron and has an inner and an outer lid. The inside of the transport cask is provided with a protective liner made of a material that has been chosen to give as little risk as possible of the canister surface being scratched. A schematic view of a KTB is shown in Figure 6-3.

The requirements for radiation shielding, strength, thermal resistance and capacity to conduct decay heat from the cask ensures that it remains air- and watertight and retains its function.

6.4.1 Insertion

The KTB is placed in the connection position, i.e. the position in which loading takes place and the inner lid is removed. Then the approved canister is lifted into the transport cask and the inner and outer lids are mounted. There is an option to exchange the atmosphere in the KTB to increase the heat transport capacity if needed. The cask is lifted out to the outgoing transport airlock, lowered into the horizontal position and secured to the cask transport frame.

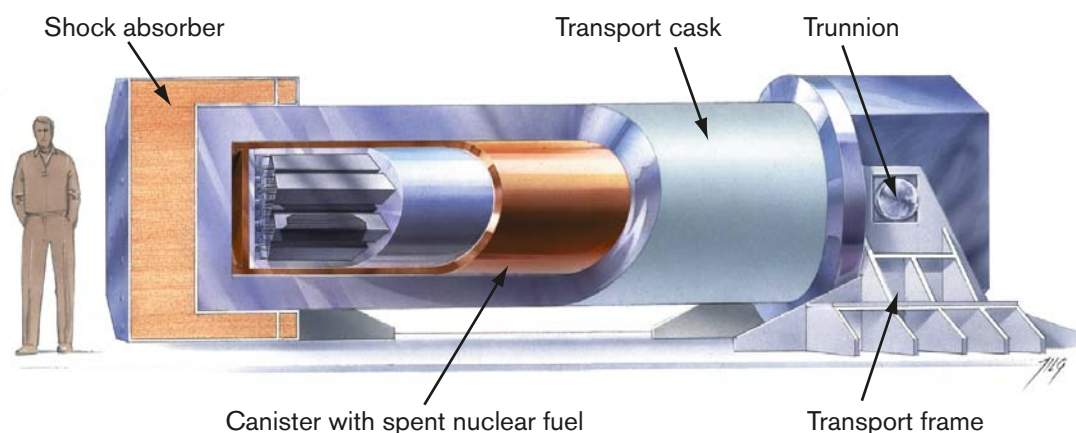

Figure 6-3. Schematic view of a canister in a transport cask (KTB). Trunnions in both ends of the cask are secured to the transport frame shown at the right end of the cask.

6.4.2 Inspection

The identity of the canister placed in the transport cask and at what date and time it happens is noted in the transport document for the KTB. The canister is thereby transferred from the encapsulation plant to the system for transportation of encapsulated spent fuel.

6.5 Transportation of KTB with canister from the encapsulation plant to final repository facility

6.5.1 Road transport to the harbour

The KTB is moved by means of a terminal vehicle to a temporary parking bay. Alternatively, it is immediately transported to the harbour by road. If anything that could have a negative effect on the canister happens during the course of transport, the KTB is returned to the encapsulation plant for inspection and analysis of the canister.

6.5.2 Sea transport

The following measures are taken with respect to the KTB /SKBdoc 1171993/.

- Embarking with terminal vehicle.
- Lashing and securing of transport cask frame in the hold of the ship.
- Sea transport to receiving port.

6.5.3 Road transport from receiving port harbour to final repository facility

The following measures are taken with respect to the KTB /SKBdoc 1171993/.

- Removal of lashings and restrainers in the hold of the ship.
- Driving ashore with terminal vehicle.
- Road transport to the operational area of the final repository where the KTB is to be delivered.

6.5.4 Inspection

At the acceptance inspection of the KTB, the transport documents are checked and verified. The canister is thereby transferred from the transportation system to the final repository facility.

6.6 Transportation of KTB down to reloading station at repository depth

6.6.1 Reloading in terminal building

The received KTB with transport frame is parked in one of the parking bays in the terminal building until it is time to move it down to the offloading station. The ramp vehicle will then collect the KTB and transport frame.

6.6.2 Transportation to repository depth

Transportation of the KTB to the reloading station at repository depth will be carried out with the aid of a ramp vehicle.

6.6.3 Inspection

During acceptance inspection of the KTB, the transport documents are checked and verified.

6.7 Reloading of the canister from the KTB to the deposition machine

6.7.1 Reloading

Handling at this stage of the process takes place in accordance with the final repository facility's operating instructions. After removal of the cask shock absorbers, the KTB is raised with the aid of an overhead crane to the vertical position and lowered into a shaft in the floor.

The lid lifting tool is manoeuvred into position and the internal lid is removed from the KTB. After this, the deposition machine is manoeuvred into place and the canister is lifted into the deposition machine radiation shielding tube.

6.7.2 Inspections

In connection with the reloading of the canister the following inspections are performed.

- Swab tests to check contamination on the inside of the KTB. Contamination of the KTB means that the canister is contaminated.
- Canister identity control.
- Surface inspection with adequate methods to detect any surface damage that the canister may have sustained. If damage has occurred it has to be investigated.

Owing to the surface dose rate of the canister, all inspections are made using remote-controlled equipment or similar.

Should the inspections of the canister reveal any form of contamination, damages, or other deviations, these must be analysed before the process continues. Either the canister is deemed to be accepted for deposition in the repository, or it is decided that the canister has to be returned to the encapsulation plant for further inspections and analysis. If the canister is returned, the sequence of events described above is carried out in reverse. Since the canister was inspected at the encapsulation plant, the discovery of defects or damage necessitating a return of the canister to the encapsulation plant is expected to be very unusual, and will basically only be necessary in the event of a mishap in connection with handling.

6.8 Deposition

The canister, which is protected by a radiation shielding tube, is transported to and positioned over the deposition hole by means of the deposition machine.

Deposition of the canister is carried out by remote control with the aid of the deposition machine.

6.8.1 Inspection

The canister identity is inspected before the deposition.

7 Initial state of the canister

The initial state refers to the properties of the engineered barriers once they have been finally placed in the final repository and will not be further handled within the repository facility. The initial state of the canister is the state when it is finally deposited.

For the assessment of the long-term safety it shall be confirmed that the canister at the initial state conforms to the design premises related to the barrier functions in the final repository. The confirmation is made through verification of:

- the conformity of the reference canister to the design premises,
- the conformity of the deposited canisters to the reference design.

The conformity of the reference design to the design premises is verified in Chapter 4 and the results are summarised in Section 4.11. In this chapter the initial state of the canister and its conformity to the reference design are presented. This chapter also presents the conclusions regarding the conformity of the finally deposited canisters to the design premises stated.

At the current stage of development and implementation there are remaining developments and test actions that need to be carried out. For example, for the PWR insert the manufacturing process is not developed to the same level as for the BWR inserts, the number of manufactured inserts is limited and the verifying analyses presented in Chapter 4 have restrictions. Therefore the following presentation regarding mechanical loads (isostatic load, shear load and uneven pressure from bentonite) in Section 7.1 and Section 7.2 only is valid for BWR inserts.

7.1 Initial state and conformity to the reference design

In this section, the initial state of the canister is presented and the conformity of the manufactured and deposited canisters to the specification given for the reference design is discussed. The section includes initial state values for the design parameters of importance for the conformity to the design premises. The other design parameters specified for the reference design are presumed to conform to the specified values. The conformity of these parameters to the reference design can generally be verified by applying conventional techniques and procedures.

7.1.1 Initial state

At this stage of development, the presented initial state of the canister is the outcome of the design parameters that can be expected based on the experiences and results from the test production presented in Chapter 5 (Sections 5.2.10, 5.3.9, 5.4.9 and 5.5.7). Initial state values for the material composition, material properties and dimensions are given in Table 7-1 to 7-3. For each design parameter reference design and initial state values are given. The initial state values are for many of the design parameters equal to the reference design. The reason is that the reference design is based on the specifications that the suppliers follow during test manufacturing and the material properties specified for the reference design is based on data from the limited number of test samples from test manufacturing. Hence, canister dimensions will conform to the reference canister at initial state. The tables also include comments and references to the sections where the experiences from the production are compiled and sections where the presented initial state values are discussed and justified.

For the assessment of the long-term safety, to allow an adequate description of the long-term evolution of the canister, a set of physical variables have been selected to describe the canister. The initial state for these variables is presented in Appendix A.

Table 7-1. Material composition at the initial state.

Component	Design parameter	Reference design	Initial state value	Comment and reference to relevant sections
Insert	Copper content (%)	<0.05	<0.05	Embrittlement Sections 5.2.10 and 7.2.6
	Iron content (%)	>90	>90	Prevent criticality
	Carbon content (%)	<6	<6	Sections 5.2.10 and 7.1.6 and 7.2.5
	Silicon content (%)	<4	<4	
Copper shell	Phosphorus (ppm)	30–100	30–100	Creep ductility Sections 5.3.9, 5.4.9, 5.5.7 and 7.2.6
	Sulphur (ppm)	<12	<12	Creep ductility Sections 5.3.9, 5.4.9, 5.5.7 and 7.2.6
	Hydrogen (ppm)	<0.6	<0.6	Brittleness during manufacturing Sections 5.3.9, 5.4.9, 5.5.7 and 7.2.6
	Oxygen (ppm)			Corrosion
	– Tube	up to some tens	<5	Sections 5.3.9 and 7.1.5
	– Lid and base	up to some tens	<5	Sections 5.4.9, and 7.1.5
	– Weld	up to some tens	up to some tens	Sections 5.5.7 and 7.1.5

Table 7-2. The material properties at the initial state.

Component	Design parameter	Reference design	Initial state value	Comment and reference to relevant sections
Insert	Compression yield strength (MPa)	>270	>270	Isostatic loads See Sections 5.2.10 and 7.1.2
	Fracture toughness K_{Ic} (MPa(m) ^{1/2})	>78	>78	
	Tensile yield strength (MPa)	>267	>267	Resistance to shear loads See Sections 5.2.10 and 7.1.3
	Fracture toughness, J_{2mm} (kJ/m)	>88	>88	
Copper shell	Elongation (%)	>40	>40	Isostatic and shear loads Sections 5.3.9, 5.4.9, 5.5.7, 7.1.2 and 7.1.3
	Creep ductility (%)	>15	>30	Isostatic and shear loads Sections 5.3.9, 5.4.9, 5.5.7, 7.1.2 and 7.1.3

7.1.2 Isostatic load in the repository

The dimensions, occurrence of defects and the material properties in the insert and in the copper shell affect the resistance to isostatic loads.

Material properties in the insert and the copper shell

The results from inspections of manufactured canister components (see Chapter 5) show that the material properties conform to the specified values and the variations both within and between components are small. This shows that the manufacturing processes are reliable and deliver canisters that conform to the material properties specified for the reference design. The specified values for the important design parameters; fracture toughness (K_{Ic}) and yield compression strength ($Rp_{0.2}$) in the manufactured series of inserts and elongation and creep ductility in the copper shell conform to the reference design, see Table 7-4.

In addition to the above mentioned design parameters, the yield tensile strength of the steel lid is described in the verifying analysis. The lids are manufactured from steel plates and delivered with certificates that verify they conform to the specified yield strength. This parameter has not been further tested and inspected in the test production.

Table 7-3. Dimensions at initial state.

Component	Design parameter	Reference design	Initial state value	Comment and reference to relevant sections
Insert BWR	Edge distance (mm)	33.3 ± 10	33.3 ± 5	Isostatic loads Sections 5.2.10 and 7.1.2
	C-C distance between compartments (mm)	210 + 1/-4	210 + 1/-4 ²	Prevent criticality Sections 5.2.10, 7.1.6 and 7.2.5
Insert PWR	Edge distance (mm)	37.3 ± 10	37.3 ± 5	Isostatic loads Sections 5.2.10 and 7.1.2
	C-C distance between compartments (mm)	370 ± 3.6	370 ± 3.6 ²	Prevent criticality Sections 5.2.10 and 7.1.6 and 7.2.5
Copper shell	Thickness (mm)			Corrosion
	– Tube	49.0	Minimum > 47.5	Sections 5.3.9, 5.4.9, 5.5.7 and 7.1.5
	– Lid, base	50.0	Fraction of canisters: > 99%	
	– Welds	48.5	45–47.5 ¹ Fraction of canisters: few per thousands Minimum < 45 ¹ Fraction of canisters: negligible	Initial state values are minimum thicknesses of the copper shell after machining, i.e. a copper shell without defects is at least this thick over its whole surface.
Copper shell	Thickness (mm)	–	< 10	Corrosion
	– Local reduction due to defects		Fraction of canisters: > 99.9%	Sections 5.3.9, 5.4.9, 5.5.7 and 7.1.5
			10–20 ¹ Fraction of canisters: one per thousands	The values for local reduction include defects induced during hot-forming and welding and surface damages induced during transportation, handling and deposition.
			20 ¹ Fraction of canisters: negligible	

¹ Values occurring only at disturbed operations considering both the manufacturing processes and inspection.

² The initial state values are based on measures from the reference design.

Table 7-4. Material properties evaluated from mechanical tests on bars from five BWR inserts and various numbers of copper components and welds compared to the reference design.

Component	Design parameter	Reference value	Average value	Standard deviation	Number of samples	Results presented in section
Insert	Compression yield strength (MPa)	>270	279.8	2.6	30	5.2.10
	Fracture toughness, K _{IC} (MPa√m)	>78	79.7	(78.0*)	24	
Copper tube	Elongation (%)	>40	60.1	2.1	8	5.3.9
	Creep ductility (%)	>15	49.3	3.0	3	
Copper lid/base	Elongation (%)	>40	55.6	4.1	10	5.4.9
	Creep ductility (%)	>15	45.9	3.6	4	
FSW	Elongation (%)	>40	51.0	2.5	14	5.5.7
	Creep ductility (%)	>15	47.1	11.1	34	

* Includes samples from various positions of the inserts, the value is the lower 90% confidence level for the population of data.

Defects in the insert

In the verifying analyses, the maximum accepted defect sizes in the insert are calculated. The results presented in Section 4.11.1 show that the acceptable defects are rather large, especially for the interior part of the insert. Examples of acceptable defects are; a maximum defect size of about 20 millimetres along the whole insert length in the outer part or a section with 400 millimetres length with total loss of material between the channels.

Results from the test manufacturing of inserts presented in Section 5.2.10 shows that the material is homogeneous. In the inserts in the demonstration series, only clustered porosity have been found located in areas where the insert withstands rather large defects (~40 millimetres along the whole length). The detection capability of the non-destructive testing methods, giving POD-values for volumetric defects of $a_{90/95}$ of circa 5 mm for the near-surface region (down to 50 mm) and below 10 mm for the deeper regions, shows that the NDT methods have margins to detect the acceptable defect size. Therefore, the risk for missing critical defects during inspection is considered low.

Insert dimensions

The important dimension for the mechanical strength needed to withstand the maximum isostatic load, is the edge distance of the insert. The specified edge distance is 33.3 ± 10 mm, giving an acceptable minimum measure of the edge distance of 23.3 mm.

The results from the test manufacturing presented in Section 5.2.10 shows that manufactured inserts conform to the specification (misalignment of 3–8 mm). When considering the actions recently performed to reduce the misalignment of the cassette and the ultrasonic measurement, the misalignment under normal production can be assumed to be ± 5 mm. The probability to exceed the specified ± 10 mm is regarded to be negligible based on the fact that the eccentricity of the cassette is inspected before and after casting as well as after machining and the ultrasonic measurement.

7.1.3 Shear load in the repository

The resistance to shear loads is affected by the material properties in the insert and the copper shell and also by the occurrence of defects in the insert.

Material properties in the insert and the copper shell

The results from performed inspections of manufactured canister components show that the material properties conform to the specified values and the variations both within and between components are small. This shows that the manufacturing processes are reliable and deliver canisters that conform to the material properties of the reference design. The inserts conform to the specified values for the important design parameters; fracture toughness (J_{2mm}) and yield tensile strength ($Rp_{0.2}$) and all copper shell components conform to the specified elongation and creep ductility, see Table 7-5.

Table 7-5. Material properties evaluated from mechanical tests on bars from five BWR inserts various numbers of copper components and welds compared to the reference design.

Component	Design parameter	Reference value	Average value	Standard deviation	Number of samples	Results presented in section
Insert	Tensile yield strength (MPa)	>267	274.3	2.6	30	5.2.10
	Fracture toughness, J_{2mm} (kN/m)	>88	90.8	88.1*	24	
Copper tube	Elongation (%)	>40	60.1	2.1	8	5.3.9
	Creep ductility (%)	>15	49.3	3.0	3	
Copper lid/base	Elongation (%)	>40	55.6	4.1	10	5.4.9
	Creep ductility (%)	>15	45.9	3.6	4	
FSW	Elongation (%)	>40	51.0	2.5	14	5.5.7
	Creep ductility (%)	>15	47.1	11.1	34	

* Includes samples from various positions of the inserts, the value is the lower 90% confidence level for the population of data.

Defects in the insert

In addition to the mechanical properties, the verifying analyses take into account the possibility of crack growth from initial defects giving limits for acceptable defect sizes in the insert. The maximum accepted depth for crack-like surface defects in the circumferential direction is 4.5 mm for semi-elliptical shape and 8.2 mm for semi-circular shape, while internal defects of > 10 mm are accepted.

Results from the test of the BWR demonstration series, presented in Section 5.2.10 show that only clustered porosity has been found in the inserts and no crack-like defects have been detected. The probability of detection for the NDT using the current preliminary inspection procedures, is for artificial crack-like defects 2–3 mm for surface defects and 4–9 mm for internal defects. However, the occurrence of real defects oriented other than in radial-circumferential directions cannot be stated as adapted inspection techniques remain to be developed.

7.1.4 Uneven pressure from bentonite buffer

The resistance to uneven pressure from the bentonite buffer is affected by the dimensions, occurrence of defects and the material properties. The canister properties and design parameters that are important for uneven loads from the bentonite buffer are in principle the same as for the isostatic load case, see Section 4.11.3 and therefore the statements in Section 7.1.2 is valid also for this case.

7.1.5 Corrosion load

The corrosion barrier function of the canister is affected by the thickness and the material composition of the copper shell.

Copper shell thickness

The copper shell thickness, i.e. the thickness perpendicular to the canister surface, is the dimension of the copper shell related to the corrosion barrier function. The thickness of the copper shell of a deposited canister is determined by:

- the nominal thickness according to the reference design,
- the efficiency of the applied techniques for machining the canister's components and welds,
- the occurrences of defects induced during hot-forming and welding processes,
- the occurrences of surface damages induced during transportation, handling in the facilities and at deposition.

This means that the copper thicknesses at the initial state is determined by all possible causes of reduction of the corrosion barrier and are based on the current experiences from the production. The initial state thicknesses are the minimum thickness that can be stated for the copper, i.e. the copper shell has at least this thickness over its whole surface. In addition, the initial state includes the fraction of canisters, which based on current experiences could have reduced minimum thicknesses after machining.

The occurrence of internal defects and surface damages will locally reduce the thickness. The stated reductions of the corrosion barrier due to defects include all the kinds of defects discussed above.

Machining of the canister's components and welds

The thicknesses of the copper shell, provided normal operations of the manufacturing and inspections, i.e. all process parameters lie within the process window and all inspected parameters conform to the specifications, is described in Chapter 5. Machining is a well-known and proven industrial process. Therefore, the methods for inspection of copper thickness has not been determined and investigated in detail by SKB. Generally it can however be concluded that mechanical inspection systems have low measurement uncertainties, less than 0.1 mm. One option is to use ultrasonic testing and at present, the measurement uncertainties are estimated to be 0.3 mm for 50 mm thick copper. According to these experiences the minimum copper thickness after machining at normal operation is judged to be; 48.4 mm for the tube, 48.7 for the base, 48.1 for the lid, including a 1 mm deep identity marking, and 47.5 mm for the welds. A compilation of the minimum copper thickness expected after machining with judged extensions is given in Table 7-6.

Table 7-6. Minimum copper thickness after machining at normal operations, including measurement uncertainties.

Component	Minimum copper shell thickness (mm) at normal operation, including measurement uncertainties	Surface extension
Tube	48.4	Less than half surface
Lid	48.1	Less than 1% of the lid surface
Base	48.7	Whole base surface
Welds (lid and base)	47.5	Weld area

Even though the manufactured and inspected canisters are assumed to have a copper thickness that exceeds these values, it can at this stage of development of the canister production not be excluded that a few canisters per thousand might have areas where the minimal copper thickness is reduced to 45 mm due to disturbed operation. This value is based on the fact that larger deviations will be detected when the components are handled, assembled and the canister is sealed, and thereby leads to rejection. Gained experiences indicate that such large deviations in dimensions can even be detected with the naked eye. The probability that any canister will have a minimum thickness after machining of less than 45 mm is therefore judged to be negligible.

Defects dependent on the hot-forming and welding processes

The occurrences of defects in the copper shell are one cause for further reduction of the corrosion barrier. The presented local reductions of the copper shell thickness due to defects from the hot-forming and welding processes are based on SKB's experience as described below. Acceptance criteria for such reductions have not yet been established by SKB and consequently, it is not possible to address the issue of rejection of canisters due to this.

The occurrences of defects in the welds have been investigated /SKBdoc 1175236/ based on the results of two welding demonstration series under normal operational conditions performed at the Canister Laboratory. Normal operation during welding means that both input and output welding process parameters are within a "process window" defined for the welds to be considered approved. The only type of defect that has been detected in the welds at normal operation is joint line hooking. In the first demonstration series, the largest detected defects were of the order of a few millimetres with the largest one being 5.4 mm in radial direction, i.e. in the direction of the corrosion barrier. The second series, the post-demonstration series was performed with an improved welding tool and resulted in smaller defects with the largest one being 1.5 mm. The observed extension of this defect in tangential direction (i.e. not in the direction of the corrosion barrier) is most likely to be of the order of some decimetres but it cannot be excluded that its extension could be along the whole weld. The demonstration series also included the evaluation of the capabilities of the non-destructive testing (NTD) procedures, i.e. the probability of detection (POD) of defects in the welds.

The evaluation of the reliability of the welding process, of its surveillance functions and of the NDT resulted in a maximum copper thicknesses reduction in the welds, during normal operations, of 10 mm for a population of 12,000 welds, corresponding to 6,000 canisters /SKBdoc 1175236/. This value is obtained by adding the maximum uncertainty in the NDT measurements, 2.1 mm, to the upper 95% confidence limit in the analysis, 7.7 mm for 4,500 and 8.2 mm for 10,000 canisters respectively. The latter values mean that it is reasonably certain (95% confidence limit) that the maximum defect size ever expected for the 6,000 canisters will not exceed 8 mm. In addition, in the evaluation of the second demonstration series it was concluded that the maximum size of the defects will not exceed 2.3 mm (with 95% confidence limit), and finally the results from POD studies of the NDT methods shows a detection capability (with 95% confidence limit), for the joint line hooking, of 90% for a 4 mm defect and close to 100% for a 10 mm defect.

The probability for disturbed operations, i.e. that one or more of the process parameters are outside the process window is estimated to be low. The probability that the process parameters are such that they cause defects that exceed 10 mm and that the process and inspection systems fail simultaneously, is at the present stage of development judged to be below one per thousand. This statement is based on the fact that the developed welding process is very reliable and reproducible. If disturbed

operations of welding and inspection occur simultaneously, the maximum reduction of the copper thickness is estimated not to exceed 20 mm. This is based on presence of a maximum joint line-hooking defect of 10 mm in combination with clearly visible wormholes with the same size.

For the rest of the copper shell, i.e. the base, lid and tube, available data on observed defects is limited /SKBdoc 1175208/. All copper components manufactured between January 2007 and May 2008, eight tubes and twenty lids, have been inspected by the preliminary NDT methods developed at the Canister Laboratory. The results of these inspections indicate that there are no defects in the extruded tubes that remain after the final machining. In the forged lids and bases one single surface defect was detected. No specific surface inspection techniques have been applied. However, the preliminary NDT methods are expected to detect possible defects, based on the fact that the defects are oriented mainly perpendicular, or have a limited angle, to the inspection plane. The orientation of the possible defects in the copper tube as well as in the copper lids and bases is mainly perpendicular to the corrosion barrier. This is due to the selected hot-forming processes which gives the main propagation axes for the defects. One exception is the possible forging laps in the lids and bases that in some specific areas can propagate in the direction of the corrosion barrier. This kind of defect is surface-breaking and will be detected by the surface inspection methods. This means that with the preliminary detection capability of the NDT methods presented in Chapter 5, the defects that remain undetected would only affect the thickness of the corrosion barrier with a few millimetres. These defects are expected to occur only within limited areas of the copper components.

Based on the fact that the possible defects in the copper components will mainly be propagated perpendicular to the corrosion barrier and on the experience that only one manufacturing defect has been found in the canister components, the welds are presently considered to be the potentially thinnest in the copper shell.

Surface damages during transportation, handling and deposition

In addition to the reduction of the copper shell thickness due to machining or possible defects, reductions may occur as a result of surface damage during transportation, handling and deposition of the canister. Available information on the occurrence of surface damage during these stages is limited since full-scale tests, which focus on this issue using relevant handling equipment and transport casks, remain to be performed.

The probability for critical reduction of the corrosion barrier due to damages occurring during transportation is, however, considered negligible since the canister is protected by a transport cask (KTB). In addition, the canister is inspected for surface damage when it is lifted from the transport cask into the radiation shield of the deposition machine in the reloading station at repository depth.

Material composition – oxygen content

The material composition is determined by the manufacturing of the copper ingots together with the following hot-forming and welding processes. The copper quality used in the ingots is a pure oxygen-free copper of a standard quality. During the course of the various hot-forming process stages, (extrusion of copper tubes, forging of lids and bases), it is primarily the material properties and structure of the copper material that are influenced. In conjunction with the welding of copper bases and lids, the weld properties are determined and the occurrence of defects inspected. The material composition in the welds is determined primarily from the basic material but the welding process may be influenced by, for example tracers being carried over from the welding tool and changes in the oxygen content. The machining of the components and welds has no influence on the material composition.

The inspection of the oxygen content at production is done by material composition analyses of samples from the bottom and top of the ingots. Analyses of the copper ingot performed during the test manufacturing shows that the oxygen content in the ingots is well below the technical specification of maximum 5 ppm. The highest measured oxygen content in eight ingots for copper tubes was 2.4 ppm and the average value was 1.1 ppm with a standard deviation of 0.5.

The highest measured oxygen content in 10 ingots for copper lids and bases was 2 ppm and the average value was 1.5 ppm with a standard deviation of 0.6.

The following hot-forming, i.e. extrusion and forging, are deemed not to have any major impact on the material composition since the material composition analyses performed on 10 forged lids where the highest measured oxygen content was 2.6 ppm and the mean value was 2.2 with a standard deviation of 0.3. There were no deviations compared to the concentrations in the ingots.

The material composition in the welds has been examined in six samples taken from three welds from the welding demonstration series and in three samples from one weld produced in argon gas. Analyses of the welds produced in air showed a mean oxygen content (with standard deviation) of 11.1 ± 12.2 ppm. The high standard deviation can be explained by the highest measured oxygen content that varies from 9 ppm in the steady-state sequence to 44 ppm in the overlap sequence. In the weld produced in argon gas the highest measured oxygen content was 2 ppm and the mean oxygen content (with standard deviation) was 1.8 ± 0.4 ppm.

To summarise, the values from the weld produced in argon gas is well below some tens of ppm stated in the design premises in Table 2-1, while the welds produced in air have an increased oxygen content in the overlap sequence.

It should be noted that the welding procedure is currently being developed to minimise oxygen content. In addition, the influence of oxides formed at the inner lid/tube interface (at the root of the weld zone) on weld integrity is under investigation.

In addition to oxygen, the welds also include traces of tool material. A clear reduction of this contaminant has been seen by introduction of a tool with PVD coating of chromenitride (CrN). The levels of Ni, Co and Cr are all less than 1 ppm to be compared to the mean levels (with standard deviation) when using non coated tools (18 samples from 3 welds) of Ni, Co and Cr that were 6.0 ± 6.8 ppm, 1.8 ± 2.8 ppm and 1.6 ± 1.8 ppm respectively /SKBdoc 1175162/.

A corrosion study /Gubner and Andersson 2007/ on the weld zones from welds made in air and with non coated tools was performed and concluded that the FSW tool is cathodic compared to the copper – small particles in the weld are cathodic protected by surrounding copper, resulting in a very small cathode compared to large copper anode. The good corrosion resistance of the FSW tool material will even further reduce the risk of corrosion of the surrounding weld material. Therefore, small metallic particles from FSW tool do not pose a risk for accelerated corrosion of the welds. The study also concluded that a negative effect of copper oxides close to the surface could not be detected.

7.1.6 Prevention of criticality

The canister production related design parameters used to verify that criticality is prevented are the carbon and silicon content in the nodular cast iron and the distance between fuel channels in the insert.

C-C distance between compartments

So far, no verification of the C-C distance between compartments by physical measurement has been done on manufactured inserts.

Material composition

The analyses of the material compositions of the nodular cast iron used for the five serial-manufactured BWR inserts and three PWR inserts are shown Table 5-1. The carbon content is below 6% and the silicon content is below 4% in all manufactured inserts.

7.2 Conformity to design premises long-term safety at the initial state

This section summarise the conformity to the design premises stated in **Design premises long-term safety** at the initial state.

7.2.1 Isostatic load in the repository

The probability for the canister not to fulfil the design requirement related to isostatic loads is deemed as insignificant. The basis for this judgement can be summarised as follows.

- The probabilistic analysis of the reference design of the canister shows that the likelihood that it does not withstand the design basis load is insignificant.
- The material properties obtained in the test manufactured components are homogeneous and fulfil the design parameters of the reference design, and the inspection of the material properties is performed by well-proven techniques.
- The accepted defect sizes based on the damage tolerance analysis is large and the full scale test manufacturing trials show that inserts that have large margins with respect to defect sizes can be produced. In addition, the detection capabilities of the non-destructive testing methods have margins that accommodate the accepted defects.
- The edge distance of the cassette within the insert under normal production varies within ± 5 mm. This, together with the quality of the different inspection procedures during manufacturing and the final ultrasonic inspection, means that the probability to exceed the accepted variation of ± 10 mm can be deemed to be insignificant.

The above statements are based on analyses of BWR inserts while the analyses of PWR inserts are limited since the development of the manufacturing technique for PWR has been carried out on a significantly smaller scale. Consequently, the experience from the various inspections performed is limited. Therefore, the damage tolerance analysis for PWR inserts has been carried out by using material data from manufactured BWR inserts. However, since the PWR design is more robust due to the higher material thickness within the cast insert, it can nevertheless be presumed that the PWR insert will conform to the design premises.

The damage tolerance analysis of the bottom of the insert is so far only conducted for crack-like defects and not for volumetric defects. However, the collapse loads without postulated defects (see Section 4.3.1) for the bottom are similar to those for the cylindrical part of the insert, indicating that also the acceptable volumetric defects will be similar. This is therefore not considered critical from the inspection point of view.

Regarding acceptable indentations in the copper shell further experimental studies and modelling of the effects from indentations and local plastic strain on the copper shell are required to better assess this kind of damage and, if required, develop acceptance criteria. The knowledge of circumstances during production, transportation and handling leading to the occurrence of this type of defect is limited and so far no effort has been spent on the development of methods for inspection of this type of damages. Based on this, the effect of small indentations on the copper shell has at this stage not been considered when describing the initial state of the canister. However, as the work progresses, further requirements may be placed on the handling and transportation of the canister and methods for inspection can be developed.

7.2.2 Shear load in the repository

The strength analysis shows that BWR canisters manufactured according to the reference design will conform to the design premises related to shear loads. However, the damage tolerance analysis gives acceptable defect sizes that put rigorous requirements on manufacturing and NDT capability. Based on results and experiences achieved so far it is expected that these additional requirements can be implemented in production and the inspection methods used for verification.

The copper shell will have sufficient ductility to remain intact also after shear loads as long as that the insert remains intact.

The initial state for the shear load case does not take into account PWR inserts as representative material data for strength analysis and damage tolerance analysis is not yet available. However, the PWR design is more robust due to greater material thicknesses within the cast insert.

It shall also be noted that the acceptable defect size in the inserts is very dependent on the bentonite density and the shear amplitude.

For the BWR inserts the following uncertainties apply to the shear load case:

- Sensitivity analysis for the material and defect parameters has not been performed in the damages tolerance analysis. Furthermore, the damages tolerance analysis needs to be further developed to give more precise input to the requirements for the NDT.
- The statistical ground for determining material properties and occurrence of defects is limited.
- NDT methods that fully meet the acceptance criteria from the damage tolerance analysis for the shear load case have not yet been developed. Hence, the detection limit for defects has not been determined.

7.2.3 Uneven pressure from bentonite buffer

The canister properties and design parameters that are important for loads from the case of uneven pressure from bentonite buffer on the canister are in principle the same as for the isostatic load case. This justifies the conclusions in Section 7.2.1, that the probability that the canister will not withstand the loads is negligible.

7.2.4 Corrosion load

The design premise for the corrosion barrier is given as a nominal thickness of 5 cm. The minimum copper thicknesses at the initial state given in Table 7-3 are the manufactured and inspected thicknesses of the corrosion barrier after the final machining of the canister components. The initial state copper thickness may locally be reduced due to the occurrence of internal defects in the copper shell and surface damages occurring during handling, transportation and deposition. The size of acceptable surface defects has at this stage not been quantified.

The oxygen content in the major part of the copper shell is well below some tens of ppm, the exception is the welds produced in air where higher values have been measured in the overlap sequence. Based on this further investigations are needed to determine if the welding process will be performed in air or in argon gas.

7.2.5 Prevention of criticality

The reference design of the insert prevents criticality.

The iron (> 90%), silicon (< 4%) and carbon (< 6%) content in the insert is verified by conventional material analyses during production. The verification parameter to prevent criticality has not yet been determined and has to be further investigated.

7.2.6 Additional design premises

This section summarised the initial state of the additional design premises.

Copper content in cast iron insert

The maximum copper content of < 0.05% in the insert is verified by conventional material analysis during production. This will guarantee that this design premises will be fulfilled.

Composition and grain size in copper shell

The material composition in the copper shell regarding content of oxygen, sulphur, phosphorus and hydrogen is verified by conventional material analysis during production. The destructive inspections during manufacturing and the following ultrasonic inspection verify that the average grain size in the copper shell will be below 360 µm. This will guarantee the conformity to these design premises.

Temperature on the surface of the copper shell

The temperature on the surface of the copper shell must not be above 100°C, this has to be considered in the instructions for handling the canister in the facilities and during transportation as well as in the detailed design of the canister transport cask (KTB). Based on current knowledge, this design premise can be met as the temperature is a parameter that is relatively trivial to measure.

8 References

SKB's (Svensk Kärnbränslehantering AB) publications can be found at www.skb.se/publications.
References to SKB's unpublished documents are listed separately at the end of the reference list.
Unpublished documents will be submitted upon request to document@skb.se.

Buffer production report, 2010. Design, production and initial state of the buffer. SKB TR-10-15, Svensk Kärnbränslehantering AB.

Design premises long-term safety, 2009. Design premises for a KBS-3V repository based on results from the safety assessment SR-Can and some subsequent analyses. SKB TR-09-22, Svensk Kärnbränslehantering AB.

Repository production report, 2010. Design and production of the KBS-3 repository. SKB TR-10-12, Svensk Kärnbränslehantering AB.

Spent fuel report, 2010. Spent nuclear fuel for disposal in the KBS-3 repository. SKB TR-10-13, Svensk Kärnbränslehantering AB.

Underground opening construction report, 2010. Design, construction and initial state of the underground openings. SKB TR-10-18, Svensk Kärnbränslehantering AB.

Andersson-Östling H C M, Sandström R, 2009. Survey of creep properties of copper intended for nuclear waste disposal. SKB TR-09-32, Svensk Kärnbränslehantering AB.

Dillström P, Bolinder T, 2010. Damage tolerance analysis of canister inserts for spent nuclear fuel in the case of an earthquake induced rock shear load. SKB TR-10-29, Svensk Kärnbränslehantering AB.

Dillström P, Alverlind L, Andersson M, 2010. Framtagning av acceptanskriterier samt skadetålig-hetsanalyser av segjärnsinsatsen. SKB R-10-11, Svensk Kärnbränslehantering AB (in Swedish).

Gubner R, Andersson U, 2007. Corrosion resistance of copper canister weld material. SKB TR-07-07, Svensk Kärnbränslehantering AB.

Hernelind J, 2010. Modelling and analysis of canister and buffer for earthquake induced rock shear and glacial load. SKB TR-10-34, Svensk Kärnbränslehantering AB.

Nilsson K-F, Lofaj F, Burström M, Andersson C-G, 2005. Pressure tests of two KBS-3 canister mock-ups. SKB TR-05-18, Svensk Kärnbränslehantering AB.

Raiko H, Sandström R, Rydén H, Johansson M, 2010. Design analysis report for the canister. SKB TR-10-28, Svensk Kärnbränslehantering AB.

Sandström R, Hallgren J, Burman G, 2009. Stress strain flow curves for Cu-OFP. SKB R-09-14, Svensk Kärnbränslehantering AB.

Unpublished documents

SKBdoc id version	Title	Issuer, year
1171993 ver 3.0	Transport av inkapslat bränsle till slutförvaring i Forsmark.	SKB, 2010
1175162 ver 4.0	Svetsning vid tillverkning och förslutning.	SKB, 2010
1175208 ver 5.0	Tillverkning av kapselkomponenter.	SKB, 2010
1175236 ver 2.0	Reliability in friction stir welding of canister.	SKB, 2009
1177857 ver 1.0	Designanalys av stållock till kapsel för använt kärnbränsle – geometriuppdatering. Produced by Inspecta Technology AB. Alverlind L, 2009.	SKB, 2009
1179633 ver 3.0	Oförstörande provning av kapselkomponenter och svetsar.	SKB, 2010
1191524 ver 1.0	Belastningsfall för kapseln under transport och hantering i inkapslings- och slutförvarsanläggningarna.	SKB, 2009
1203875 ver 1.0	Ritningsförteckning för kapselkomponenter.	SKB, 2009
1206868 ver 1.0	Damage tolerance analysis of the copper shell in PWR and BWR canisters during handling of the entire canister. Produced by Inspecta Technology AB. Bolinder T, 2009.	SKB, 2009

SKBdoc id version	Title	Issuer, year
1207426 ver 1.0	Updated probabilistic analysis of canister inserts for spent nuclear fuel. Produced by Inspecta Technology AB. Dillström P, 2009.	SKB, 2009
1207429 ver 1.0	Canister bottom structural integrity. Canister bottom structural integrit. Produced by Inspecta Technology AB. Alverlind L, 2009.	SKB, 2009
1207576 ver 2.0	Test of mechanical properties on cast iron inserts for encapsulation of nuclear waste, summary report.	SKB, 2009

Initial state of the variables used for the long term evolution of the canister cast iron insert and copper shell

For the assessment of the long-term safety a set of physical variables has been selected to allow an adequate description of the long-term evolution of the canister cast iron insert and copper shell. Initial state values for these variables can generally be derived from the designed and inspected canister properties presented in Chapter 7, or other information recorded during the production of the canister. However, for some of the variables initial state values must be derived from other sources. In Table A-1 the variables and corresponding designed and inspected properties and other sources from which initial state values of the variables can be derived are presented.

Table A-1. The variables used in the safety assessment and the related canister properties, and other sources, from which initial state values of the variables can be derived.

Variable	Canister property	Source or comment
Canister geometry	Dimensions	Chapter 7 (Initial state) and Chapter 3 (Reference canister) in this report.
Radiation intensity		Radiation at canister surface, see Section 3.1.5 in Spent fuel report .
Temperature		Section 7.2.6 (Additional design premises) in this report.
Mechanical stress		The residual stresses in the canister at initial state are insignificant, see Section 7.3.2 (insert) and 6.2.10 (copper shell) in /Raiko et al. 2010/.
Material composition	Material composition	Chapter 7 (Initial state) and Chapter 3 (Reference canister) in this report.

Glossary of abbreviations and specialised terms used in Canister production report

The glossary is intended to explain all acronyms, SKB-specific terms, and technical terms that occur often in this report. It is not intended to contain all technical terms found in the report. Chemical Formulae and units are usually not included in the glossary.

ASME	American Society of Mechanical Engineers.
BAM	Federal Institute for Materials Research and Testing in Berlin.
BWR	Boiling water reactor.
FEM	Finite Element Method – a numerical method for solving partial differential equations.
FSW	Friction stir welding.
IAEA	International Atomic Energy Agency.
KBS-3	SKB's reference method for disposal of spent nuclear fuel.
KTB	Transport cask for encapsulated spent fuel.
MOX	Mixed oxide fuel.
NDT	Non-destructive testing.
POD	Probability of detection.
PSAR	Preliminary Safety Analysis Report.
PWR	Pressurised Water Reactor.
SR-Can	Report on long-term safety of the final repository (published by SKB in November 2006).
SR-Site	Report on long-term safety of the final repository.
95% confidence limit	The limit(s) of a 95% confidence interval. In a long series of independent samples, the relative frequency of cases where the true value of a parameter is covered by confidence interval is greater than or equal to 0.95. This measure can be explained as the uncertainty in the parameter estimates of the statistical model such that results can be considered to be reasonably certain.
$a_{90/95}$	The value "a90/95" that has been used as a measure of the reliability means that defects will to 90% be detected within a confidence range of 95%, i.e. the level of uncertainty in determining the detection capability.
Barrier	See Repository production report , Section 1.5.
Barrier function	See Repository production report , Section 1.5.
Copper shell	Copper tube, lid and base.
Cassette	Steel tube cassette, which is welded together from square profiled tubes, and embedded into a nodular cast iron insert.
Channel tube	Square profiled steel tube that forms a channel for spent fuel assemblies in the nodular cast iron insert.
Design parameter	The designs of the engineered barriers and underground openings are defined by a set of design parameters which are related to the properties that shall provide the required functions.
Design premises	See Repository production report , Section 1.5.
Initial state	See Repository production report , Section 1.5.
Nodular cast iron	The cast iron material chosen for the insert, a pressure-bearing canister component, is nodular cast iron, where the graphite is formed in nodules.
PVD	Physical vapour deposition.
Reference design	See Repository production report , Section 1.5.
Technical specifications	Certain specifications addressed to suppliers of canister components may be more stringently formulated than in the reference design in order to secure wider margins from the manufacturing.
Ågesta	Nuclear heat electric station placed in Ågesta.